

PRODUCT CATALOGUE 2020

Automated
systems for gates,
garages,
industrial doors
and barriers

GENIUS[®]

General Index

How to read the catalogue	6
Kits	8
Product families	16
Control boards	60
Accessories	70
General conditions of sale	81
Analytical index by code	85

Product Index



KITS

KITS	8
------	---



Automated systems for SWING GATES

G-Bat	18
Sirocco	20
Mistral	22
Compas	24
Trigon 02	26
Diablo	28
Roller	30



Automated systems for SLIDING GATES

Blizzard 230V	34
Blizzard 24V	36
Falcon M14 - M20	38



Automated systems for GARAGE DOORS Automated systems for ROLLING SHUTTERS

Euro Breeze 06	42
Zodiac	44
Shutter	46



Automated systems for INDUSTRIAL DOORS

Trigon K	50
----------	----



AUTOMATIC BARRIERS

Spin	54
Rainbow	57



From ideas to automated system

Genius is a FAAC Group brand which designs and manufactures client-focused automated systems.

The skill and experience of Genius, coupled with the cutting-edge technology structures of the industry-leading Group in which it plays a key role, tangibly set Genius apart from competitors, and allows it to offer **unrivalled quality of products** and services.

This is why
choosing **Genius** means ensuring
reliability and **safety**

- **Extensive range:** products for every application requirement with an **excellent quality/price ratio**.
- **Tests on all products:** all products are **100% tested and approved**.
- Products **which are easy to install**, thanks to technologies like **G-Way** (Bus technology), and **safe**, thanks to devices like the **virtual encoder**.
- **Comprehensive** technical, commercial and marketing support.
- Complimentary, multilevel technical **refresher courses**.
- A rapid and efficient **technical support Service**.
- **Complete support** in achieving conformity with European safety standards.

GENIUS SAFE GATE PROJECT

For a world of automation with total peace of mind.



GENIUS[®]

The **GENIUS SAFE GATE PROJECT** represents a new way of approaching the world of automated systems in compliance with the standards of the current European Directive on safety (MD 2006/42/EC).

The GENIUS SAFE GATE PROJECT programme suggests automated electromechanical systems (with 230VAC or 24VDC voltage), which, thanks to the use of advanced electronic control boards and devices such as the new PROcoder absolute encoder, allow users to build fully-compliant systems as well as updating existing systems, without the need to replace the automated devices.



How to read the catalogue

Name of the product | Family | Operating voltage | Technologies

G-Bat

use PROcoder to get maximum safety

MOTOR FOR SWING GATES

- Available versions: 230V and 24V
- The 24V model is standard equipped with ENV function (Virtual Encoder) - **PATENT**
- Leaves up to 3 m (230V and 24V) and 4 m (only 230V)
- G-WAY system in 24V version (with Brain 15 Control Board) or in 230 V version (with Brain 17 Control Board)
- **PRO-CODER** Safety System (with Brain 17 Control Board)
- Easy release through a user friendly lever
- Sturdy inner kinematic mechanism made of a bronze crown and steel worm-screw
- Opening and closing slow down available in both versions
- Possibility of adding a rod cover housing.

Code	Name	Version	Voltage	Leaf max. length	Use
6170026	G-Bat 300 RH	Non-reversible right	230V	3 m.	Residential
6170027	G-Bat 300 LH	Non-reversible left	230V	3 m.	Residential
6170030	G-Bat 400 RH	Non-reversible right	230V	4 m.	Residential
6170031	G-Bat 400 LH	Non-reversible left	230V	4 m.	Residential
6170038	G-Bat 324 ENV RH	Non-reversible right	24V	3 m.	Residential
6170039	G-Bat 324 ENV LH	Non-reversible left	24V	3 m.	Residential

OPERATOR DIMENSIONS

Technical Specifications	G-Bat 300	G-Bat 400	G-Bat 324 ENV
Power supply (V)	230	230	230
Electric motor (V)	230	230	24
Nominal power (W)	280		35
Current (A)	1.2		-
Thermal Protection (°C)	140		-
Thrust capacitor (µF)	8		-
Thrust (daN)		350	150
Travel (mm)	300	400	300
Max. speed (cm/sec.) ¹		1.6	2.1
Frequency of use at 20 °C		S3 - 30%	Continuous
Operating ambient temperature (°C)		-20 +55	
Protection class		IP54	
Weight (kg)	6.5	7	7.5

CONTROL BOARDS

Brain 17 Page 64
Brain 592 Page 64
Brain 15 Page 65

1 - The max. rod exit speed can change according to the weight and friction of the gate. Over 2.5 m, an electric lock is essential to ensure leaf blocking.





18

THE TECHNOLOGIES

ENV PATENT Virtual Nominal Encoder – **PATENT**. Fitted on 24V motors, this consists of an electronic circuit that detects the exact gate position, making it possible to manage the deceleration of the gate leaf and the obstacle detection with extremely high precision. Motors with this feature (ENV) can only be managed via the BRAIN 15 (swing-leaf gates) control board.

Exclusive BUS connection for photocells and/or absolute encoder (**PROcoder**). It makes electrical connections easier as it only requires two wires and allows the application of up to 16 pairs of photocells (VEGA BUS), which can only be addressed using built-in dip-switches on the photocell. Only present on BRAIN 15 (24V) and BRAIN 17 (230V) control boards.

KEY

-  Automated systems for **SWING GATES**
-  Automated systems for **SLIDING GATES**
-  Automated systems for **GARAGE DOORS and ROLLING SHUTTERS**
-  Automated systems for **INDUSTRIAL DOORS**
-  **AUTOMATIC BARRIERS**

Voltage



Technologies



BUS



PATENT

Table of typical installation

Photo and brief description of accessories

Installation diagram for the product

Indicator colour for the family

ELECTRIC WIRING DIAGRAM

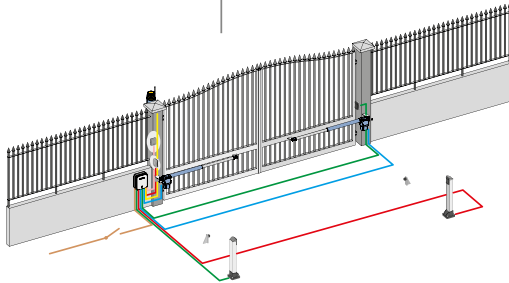

- Line3x1,5 mm²
- Motor*4x1,5 mm²
- Flashing lamp2x1,5 mm²
- Selector2x0,5 mm²
- TX photocells2x0,5 mm²
- RX photocells4x0,5 mm²

* For 24Vdc motors, use 2x2.5 mm² cables - max. distance between motor and control unit 10 m, provide a cable for encoder of 3x0.5 mm²

TYPICAL INSTALLATION EXAMPLE

Q.ty	Material description	Part number
1	G-BAT 300 Motor RH	6170026
1	G-BAT 300 Motor LH	6170027
1	Electronic Control Board BRAIN 592	JA592
1	RC 433 one-channel receiver	6100110
1	Electronic Control Board Enclosure	JA320
1	Four-Channel Transmitter ECHO TX4 RC	6100334
1	230V GUARD Flashing Lamp	6100052
1	VEGA Photocells	6100147
1	QUICK 1 key-operated selector for outdoor use	JA31101-15
TOTAL (VAT EXCLUDED)		

Material to add in order to get the configuration as per Wiring Diagram

Q.ty	Material description	Part number
1	Pair of ORION photocells	JA310
2	Column for photocell	JA325
2	Foundation plate for column	JA328

ACCESSORIES

					
PLATE Kit of 6 fixing plates. 110x70x5 mm.	BRACKET Kit of 6 rear brackets h. 160 mm.	BRACKET Kit of 6 rear brackets h. 130 mm. NOT for 324 ENV	BATTERY KIT With recharging board. Only for 24V models	CARTER KIT 2 Rod cover casing For G-BAT 300 and 324 ENV	PROcoder G-BAT*
Code 58P0199	Code 6100253	Code 6100043	Code 390923	Code 6100254	Code 6100324

*To be used with Brain 15 or Brain 17 electronic control boards.

PROcoder (BUS magnetic absolute encoder) - A geometric detection system for determining the exact position of the gate leaf.

PROcoder is a device that can be used on the compatible swing-leaf automated systems, both 230V and 24V, even if already installed, without the need to change the size of the support brackets. It provides extremely high precision in gate leaf position reading (0.2°), and allows users to easily meet standard requirements in terms of anti-crushing safety. In the event of an electrical power cut, the deceleration and stop positions remain unchanged (ABSOLUT SYSTEM) for maximum user comfort.

It can be used with the BRAIN15 (for 24V swing-leaf gates) or BRAIN 17 (for 230V swing-leaf gates) boards.



KITS

Selection

GUIDE

Kits

Swing gates

G-Bat Kit Page 10
Mistral Kit Page 11
Compas Kit Page 12

Sliding gates

Blizzard ENC Kit 500/900 Page 13
Blizzard ENC Kit 400 Page 14

G-Bat Kit



KIT FOR GATES WITH TWO SWING LEAVES

Kit complete with accessories (see list), suitable to automate a two-leaf gate (max. width of 3.00 m per leaf).

ACCESSORIES



CARTER KIT
2 Rod cover casing
For G-BAT 300 and 324 ENW

Code **6100254**

Individual components of the Kit:

51701271 G-Bat Kit - 433 MHz frequency - RC

Code	Name	Q.ty	Page
6170026	Electro-mechanical operator G-Bat 300 RH	1	18
6170027	Electro-mechanical operator G-Bat 300 LH	1	18
JA592	Brain 592 Electronic Control Board	1	-
JA320	Enclosure for Electronic Control Board	1	-
6100354	433 MHz one-channel receiver	1	77
6100334	Four-channels transmitter ECHO TX4	1	79
6100147	Vega Photocells	1	72
JA31101	Quick 1 key-operated selector	1	75
6100052	Guard Flashing Lamp 230V	1	74
-	Warning Sign	1	-
-	Installation Accessories	2	-
-	Installation Instructions	1	-

Individual components of the Kit:

51701281 G-Bat Kit - 868 MHz frequency - JLC

Code	Name	Q.ty	Page
6170026	Electro-mechanical operator G-Bat 300 RH	1	18
6170027	Electro-mechanical operator G-Bat 300 LH	1	18
6100304	Brain 17 Electronic Control Board	1	64
JA320	Enclosure for Electronic Control Board	1	-
6100332	two-channels transmitter KILO TX2	1	77
6100147	Vega Photocells	1	72
JA31101	Quick 1 key-operated selector	1	75
6100052	Guard Flashing Lamp 230V	1	74
6100347	3 PINS Plug-in RQFZ Frequency Module 868 MHz	1	77
-	Warning Sign	1	-
-	Installation Accessories	2	-
-	Installation Instructions	1	-

Complete Kit:

Code	Model	Voltage	Leaf max. length	Pcs./Pallet
51701271	G-Bat Kit - 433 MHz frequency - RC	230V	3 m.	15
51701281	G-Bat Kit - 868 MHz frequency - JLC	230V	3 m.	15

Mistral Kit



KIT FOR GATES WITH TWO SWING LEAVES

Kit complete with accessories (see list), suitable to automate a two-leaf gate (max. width of 3.00 m per leaf).

Individual components of the Kit:

51700931 Mistral Kit - 868 MHz frequency - JLC

Code	Name	Q.ty	Page
6170116	Electro-mechanical operators Mistral 300	2	22
6100304	Brain 17 Electronic Control Board	1	64
JA320	Enclosure for Electronic Control Board	1	-
6100332	two-channels transmitter KILO TX2	1	77
6100147	Vega Photocells	1	72
JA31101	Quick 1 key-operated selector	1	75
6100052	Guard Flashing Lamp 230V	1	74
6100347	3 PINS Plug-in RQFZ Frequency Module 868 MHz	1	77
-	Warning Sign	1	-
-	Installation Accessories	2	-
-	Installation Instructions	1	-

Complete Kit:

Code	Model	Voltage	Leaf max. length	Pcs./Pallet
51700931	Mistral Kit - 868 MHz frequency - JLC	230V	3 m.	12

Compas Kit



KIT FOR GATES WITH TWO SWING LEAVES

Kit complete with accessories (see list), for residential use, suitable to automate a two-leaf gate (max. length of 2.50 m and max. weight 310 kg per leaf).

Individual components of the Kit:

51700811 Compas Kit - 868 MHz frequency - JLC

Code	Name	Q.ty	Page
6170135	Electro-mechanical operator Compas 24	1	24
6170136	Electro-mechanical operator Compas 24 C (integrated electronic control board)	1	24
6100332	two-channels transmitter KILO TX2	1	77
6100148	BUS Vega Photocells	1	72
JA31101	Quick 1 key-operated selector	1	75
6100054	Guard Flashing Lamp 24V	1	74
6100347	3 PINS Plug-in RQFZ Frequency Module 868 MHz	1	77
-	Warning Sign	1	-
-	Installation Accessories	2	-
-	Installation Instructions	1	-

Complete Kit:

Code	Model	Voltage	Leaf max. length	Pcs./Pallet
51700811	Compas Kit - 868 MHz frequency - JLC	24V	2.50 m.	-

N.B. The transmission arm is included in the motor box. The maximum distance between the leaf hinge and the heart of the system must not exceed 220 mm.

Blizzard ENC Kit 500/900



integrated encoder



KIT FOR SLIDING GATES

Kit suitable for automating a sliding gate having a maximum weight of 500 kg and 900 kg complete with accessories (see list).

Individual components of the Kit:

104006 BLIZZARD ENC KIT 500 frequency 868 MHz - JLC

Code	Name	Q.ty	Page
61100821	Blizzard ENC 500 eletro-mechanical operator (with Sprint 382 control board, integrated encoder and key protected lever release.	1	34
-	Foundation plate (included in the kit)	1	-
6100332	two-channels transmitter KILO TX2	1	77
6100147	Vega Photocells	1	72
JA31101	Quick 1 key-operated selector	1	75
6100052	Guard Flashing Lamp 230V	1	74
6100352	5-PIN one-channel receiver 868 MHz	1	77
-	Warning Sign	1	-
-	Installation Accessories	1	-
-	Installation Instructions	1	-

Individual components of the Kit:

104006 BLIZZARD ENC KIT 900 frequency 868 MHz - JLC

Code	Name	Q.ty	Page
61100861	Blizzard ENC 900 eletro-mechanical operator (with Sprint 382 control board, integrated encoder and key protected lever release.	1	34
-	Foundation plate (included in the kit)	1	-
6100332	two-channels transmitter KILO TX2	1	77
6100147	Vega Photocells	1	72
JA31101	Quick 1 key-operated selector	1	75
6100052	Guard Flashing Lamp 230V	1	74
6100352	5-PIN one-channel receiver 868 MHz	1	77
-	Warning Sign	1	-
-	Installation Accessories	1	-
-	Installation Instructions	1	-

Complete Kit:

Code	Model	Voltage	Leaf Weight	Pcs./Pallet
104001	Blizzard ENC kit 500 - 868 MHz frequency - JLC	230V	500 kg	39
104002	Blizzard ENC kit 900 - 868 MHz frequency - JLC	230V	900 kg	39

Blizzard ENC Kit 400



integrated encoder



KIT FOR SLIDING GATES

Kit adatto a motorizzare un cancello scorrevole di peso max. 400 kg completo di accessori (vedi lista).

Individual components of the Kit:

104006 BLIZZARD ENC KIT 400 frequency 868 MHz - JLC

Code	Name	Q.ty	Page
6110080	Blizzard ENC 400 eletro-mechanical operator (with Sprint 24 control board, integrated encoder and key protected lever release.	1	36
737000	Foundation Plate for Blizzard	1	-
6100148	Pair of VEGA BUS Photocells	1	72
6100332	two-channels transmitter KILO TX2	1	77
JA31101	Quick 1 key-operated selector	1	75
6100347	RQFZ 868 MHz Frequency Module	1	77
6100054	24V GUARD Flashing Lamp	1	74
-	Warning Sign	1	-
-	Installation Accessories	1	-
-	Installation Instructions	1	-

Complete Kit:

Code	Model	Voltage	Leaf Weight	Pcs./Pallet
104005	Blizzard ENC kit 400 - 868 MHz frequency - JLC	24V	400 kg	39





Automated systems for
SWING GATES

Selection

GUIDE

Swing gates

External

Leaf max. length 2.5 m.

230V

Sirocco 250 Page 20

24V

Sirocco 2524 Page 20

Leaf max. length 3.0 m.

230V

G-Bat 300 Page 18

Mistral 300 Page 22

24V

G-Bat 324 ENV Page 18

Mistral T324 ENV Page 22

Mistral 324 Page 22

Leaf max. length 4.0 m.

230V

G-Bat 400 Page 18

Mistral 400 Page 22

24V

Mistral 424 Page 22

Articulated

Leaf max. length 2.5 m.

24V

Compas Page 24

Leaf max. length 3.0 m.

230V

Trigon 02 Page 26

Underground

Leaf max. length 2.5 m.

24V

Diablo Page 28

Leaf max. length 3.5 m.

230V

Roller Page 30



Easy release of the automated system

use PROcoder to get maximum safety



The sturdy inner kinematic mechanism guarantees long life

MOTOR FOR SWING GATES

- Available versions: 230V and 24V
- The 24V model is standard equipped with ENV function (Virtual Encoder) - **PATENT**
- Leaves up to 3 m (230V and 24V) and 4 m (only 230V)
- G-WAY system in 24V version (with Brain 15 Control Board) or in 230 V version (with Brain 17 Control Board)
- **PRO-CODER** Safety System (with Brain 17 Control Board)
- Easy release through a user friendly lever
- Sturdy inner kinematic mechanism made of a bronze crown and steel worm-screw
- Opening and closing slow down available in both versions
- Possibility of adding a rod cover housing.

Code	Name	Version	Voltage	Leaf max. length	Use
6170026	G-Bat 300 RH	Non-reversible right	230V	3 m.	Residential
6170027	G-Bat 300 LH	Non-reversible left	230V	3 m.	Residential
6170030	G-Bat 400 RH	Non-reversible right	230V	4 m.	Residential
6170031	G-Bat 400 LH	Non-reversible left	230V	4 m.	Residential
6170038	G-Bat 324 ENV RH	Non-reversible right	24V	3 m.	Residential
6170039	G-Bat 324 ENV LH	Non-reversible left	24V	3 m.	Residential

OPERATOR DIMENSIONS



Technical Specifications	G-Bat 300	G-Bat 400	G-Bat 324 ENV
Power supply (V)		230	230
Electric motor (V)		230	24
Nominal power (W)		280	35
Current (A)		1.2	-
Thermal Protection (°C)		140	-
Thrust capacitor (µF)		8	-
Thrust (daN)		350	150
Travel (mm)	300	400	300
Max. speed (cm/sec.) ¹		1.6	2.1
Frequency of use at 20 °C		S3 - 30%	Continuous
Operating ambient temperature (°C)		-20 +55	
Protection class		IP54	
Weight (kg)	6.5	7	7.5

CONTROL BOARDS

Brain 17	Page 64
Brain 592	Page 64
Brain 15	Page 65

1 - The max. rod exit speed can change according to the weight and friction of the gate. Over 2.5 m, an electric lock is essential to ensure leaf blocking.

ELECTRIC WIRING DIAGRAM

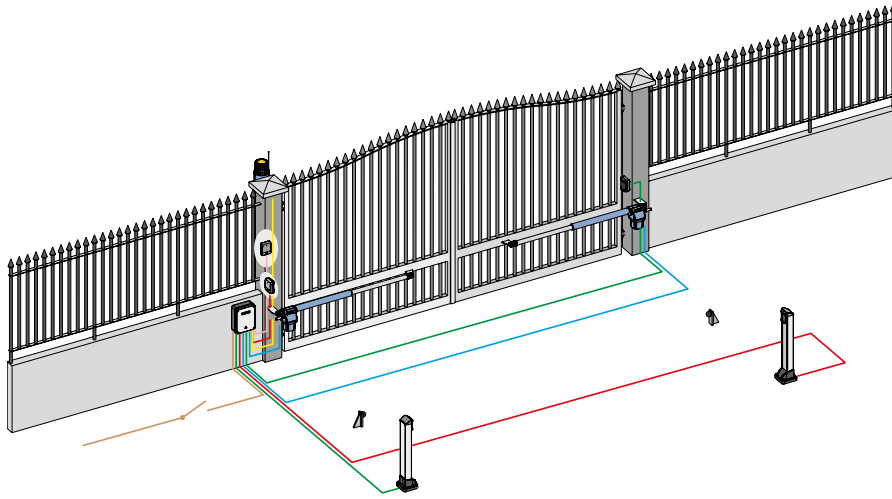

- Line3x1,5 mm²
- Motor*4x1,5 mm²
- Flashing lamp2x1,5 mm²
- Selector2x0,5 mm²
- TX photocells2x0,5 mm²
- RX photocells4x0,5 mm²

* For 24Vdc motors, use 2x2.5 mm² cables - max. distance between motor and control unit 10 m, provide a cable for encoder of 3x0.5 mm²

TYPICAL INSTALLATION EXAMPLE

Q.ty	Material description	Part number
1	G-BAT 300 Motor RH	6170026
1	G-BAT 300 Motor LH	6170027
1	Electronic Control Board BRAIN 592	JA592
1	RC 433 one-channel receiver	6100354
1	Electronic Control Board Enclosure	JA320
1	Four-Channel Transmitter ECHO TX4 RC	6100334
1	230V GUARD Flashing Lamp	6100052
1	VEGA Photocells	6100147
1	QUICK 1 key-operated selector for outdoor use	JA31101-15

Material to add in order to get the configuration as per Wiring Diagram

Q.ty	Material description	Part number
1	Pair of ORION photocells	JA310
2	Column for photocell	JA325
2	Foundation plate for column	JA328

ACCESSORIES



PLATE
Kit of 6 fixing plates.
110x70x5 mm.

Code **58P0199**



BRACKET
Kit of 6 rear brackets h. 160 mm.

Code **6100253**



BRACKET
Kit of 6 rear brackets h. 130 mm.
NOT for 324 ENV

Code **6100043**



BATTERY KIT
With recharging board.
Only for 24V models

Code **390923**



CARTER KIT
2 Rod cover casing
For G-BAT 300 and 324 ENV

Code **6100254**



PROcoder G-BAT*

Code **6100324**

*To be used with Brain 15 or Brain 17 electronic control boards.

use PROcoder to get maximum safety



MOTOR FOR SWING GATES

- Float bracket (out of axis thrust)
- Available versions: 230V and 24V
- Leaves up to 2.5 m
- G-WAY system in 24V version (with Brain 15 Control Board) in 230 V version (with Brain 17 Control Board)
- **PROcoder** Safety System (with Brain 17 Control Board)
- Release through a user friendly accessory lever and customised key
- Sturdy inner kinematic mechanism made of a bronze crown and steel worm-screw
- Opening and closing slow down available in both versions
- Horizontal output cables (installation closed to floor)
- Double painting layer
- Integrated mechanical stops.

Code	Name	Version	Voltage	Leaf max. length	Use
6170124	Sirocco 250	Non-reversible	230V	2.5 m.	Residential / condominium
6170126	Sirocco 2524	Non-reversible	24V	2.5 m.	Residential / condominium

OPERATOR DIMENSIONS

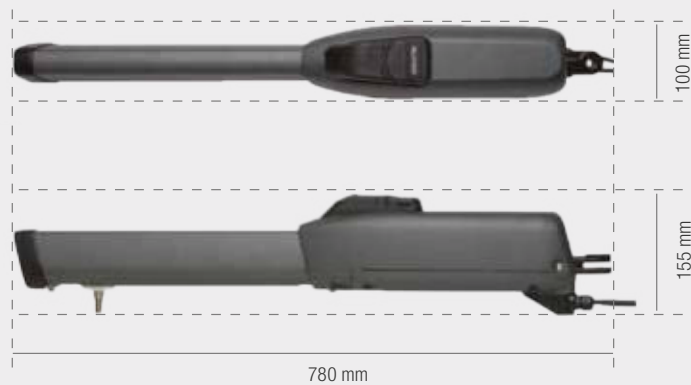

Technical Specifications	Sirocco 250	Sirocco 2524
Power supply (V)	230	230
Electric motor (V)	230	24
Nominal power (W)	250	70
Current (A)	1.1	3
Thermal Protection (°C)	140	-
Thrust capacitor (µF)	6.3	-
Thrust (daN)	200	250
Travel (mm)	300 (350 mm without mechanical stops)	
Max. speed (cm/sec)	1.6	
Frequency of use at 20 °C	S3 - 30%	continuous
Operating ambient temperature (°C)	-20 +55	
Protection class	IP54	
Weight (kg)	6,5	

CONTROL BOARDS

Brain 17	Page 64
Brain 592	Page 64
Brain 15	Page 65

N.B.
Over 1.80 m, an electric lock is essential to ensure leaf blocking.

ELECTRIC WIRING DIAGRAM

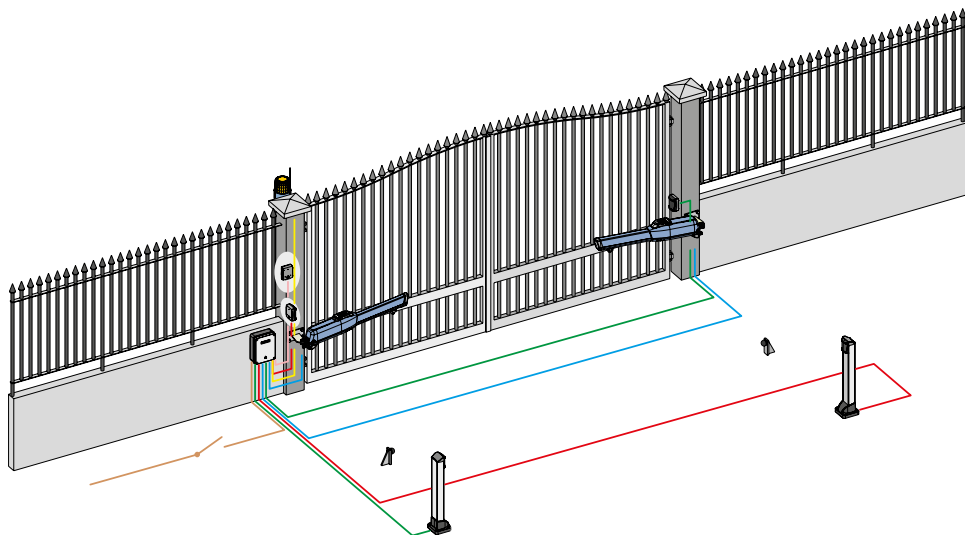

- Line 3x1,5 mm²
- Motor* 4x1,5 mm²
- Flashing lamp 2x1,5 mm²
- Selector 2x0,5 mm²
- TX photocells 2x0,5 mm²
- RX photocells 4x0,5 mm²

* For 24Vdc motors, use 2x2,5 mm² cables - max. distance between motor and control unit 10m, provide a cable for encoder of 3x0,5 mm²

TYPICAL INSTALLATION EXAMPLE

Q.ty	Material description	Part number
2	250 SIROCCO Motors	6170124
1	Electronic Control Board BRAIN 592	JA592
1	RC 433 one-channel receiver	6100354
1	Electronic Control Board Enclosure	JA320
1	Four-Channel Transmitter ECHO TX4 RC	6100334
1	230V GUARD Flashing Lamp	6100052
1	VEGA Photocells	6100147
1	QUICK 1 key-operated selector for outdoor use	JA31101-15

Material to add in order to get the configuration as per Wiring Diagram

Q.ty	Material description	Part number
1	Pair of ORION photocells	JA310
2	Column for photocell	JA325
2	Foundation plate for column	JA328

ACCESSORIES



PLATE
Kit of 6 fixing plates.
110x70x5 mm.

Code **58P0199**



BRACKET
Kit of 6 rear brackets h. 160 mm.

Code **6100253**



PROcoder*

Code **6100335**



BATTERY KIT
With recharging board.
Only for 24V models

Code **390923**

*To be used with Brain 15 or Brain 17 electronic control boards.

use PROcoder to get maximum safety

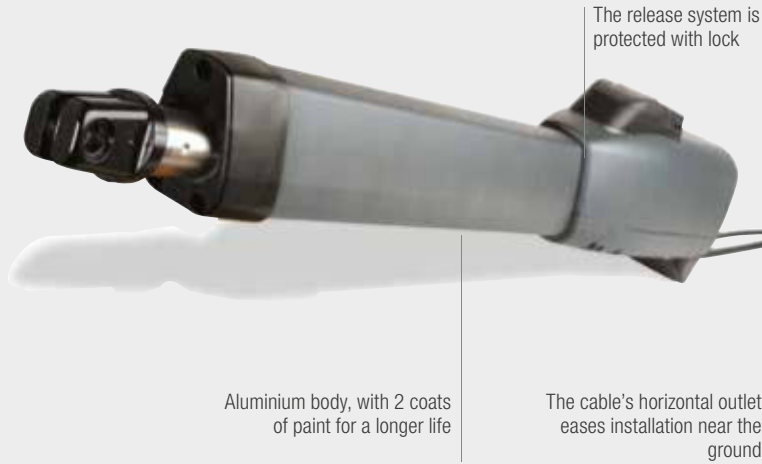

MOTOR FOR SWING GATES

- Available versions: 230V and 24V
- Leaves up to 4 m
- The 24V model is standard equipped with ENV function (Virtual Encoder) - **PATENTED**
- G-WAY system in 24V version (with Brain 15 Control Board) or in 230 V version (with Brain 17 Control Board)
- **PROcoder** safety system (with Brain 15 AND Brain 17 Control Board)
- Release through a user friendly accessory lever and customised key
- Sturdy inner kinematic mechanism made of a bronze crown and steel worm-screw
- Opening and closing slow down available in both versions
- Electric limit switches version (no need of opening and closing slow down)
- Horizontal output cables (installation closed to floor)
- Double painting layer.

Code	Name	Version	Voltage	Leaf max. length	Use
6170116	Mistral 300	Non-reversible	230V	3 m.	Condominium
6170117	Mistral 300 LS	Non-reversible / limit-switches	230V	3 m.	Condominium
6170120	Mistral 400	Non-reversible	230V	4 m.	Condominium
6170121	Mistral 400 LS	Non-reversible / limit-switches	230V	4 m.	Condominium
6170118	Mistral 324	Non-reversible	24V	3 m.	Condominium
6170178	Mistral T324 ENV	Non-reversible	24V	3 m.	Residential
6170122	Mistral 424	Non-reversible	24V	4 m.	Condominium

OPERATOR DIMENSIONS

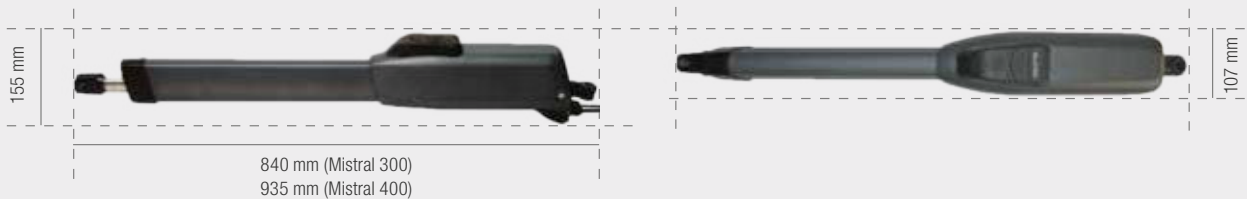

Technical Specifications	300	300 LS	400	400 LS	324	T324 ENV	424
Power supply (V)	230				230		
Electric motor (V)	230				24		
Nominal power (W)	300				70	35	70
Current (A)	1.3				3		
Thermal Protection (°C)	140				-		
Thrust capacitor (µF)	8	8	8	8	-		
Thrust (daN)	300	300	300	300	280	150	280
Travel (mm)	300		400		300		400
Max. speed (cm/sec)	1.6				2.1		1.6
Frequency of use at 20 °C	S3 - 30%	S3 - 35%	S3 - 30%	S3 - 35%	continuous		
Operating ambient temperature (°C)	-20 +55	-20 +55			-20 +55		
Protection class	IP54						
Weight (kg)	7.8		8		7.8	7.5	8

N.B.
Over 2.5 m, an electric lock is essential to ensure leaf blocking.
In 400 models, with leaves over 3 m, an electric lock is essential to ensure leaf blocking.

ELECTRIC WIRING DIAGRAM

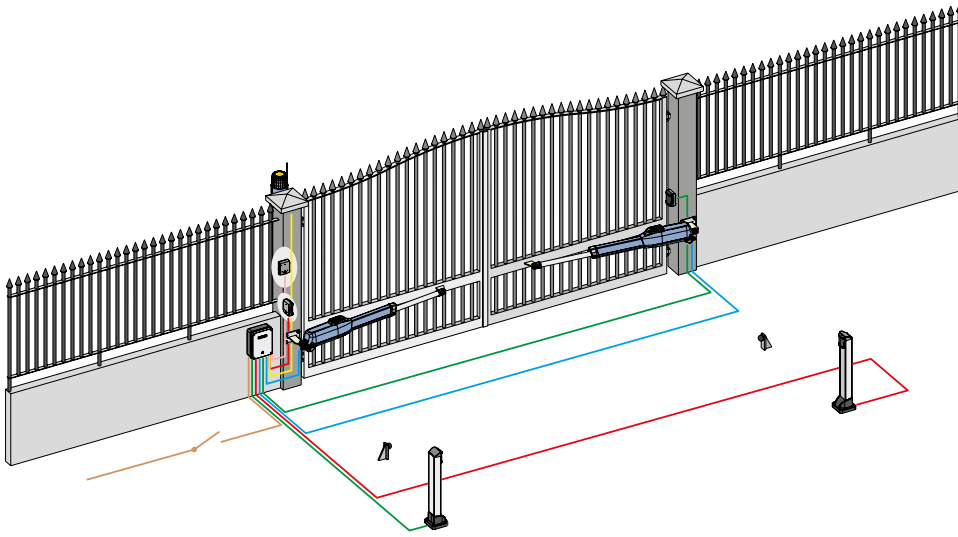

- Line3x1,5 mm²
- Motor*4x1,5 mm²
- Flashing lamp2x1,5 mm²
- Selector2x0,5 mm²
- TX photocells2x0,5 mm²
- RX photocells4x0,5 mm²

* For 24Vdc motors, use 2x2.5 mm² cables - max. distance between motor and control unit 10m, provide a cable for encoder of 3x0.5 mm²

TYPICAL INSTALLATION EXAMPLE

Q.ty	Material description	Part number
2	MISTRAL 300 Motors	6170116
1	Electronic Control Board BRAIN 592	JA592
1	RC 433 one-channel receiver	6100354
1	Electronic Control Board Enclosure	JA320
1	Four-Channel Transmitter ECHO TX4 RC	6100334
1	230V GUARD Flashing Lamp	6100052
1	VEGA Photocells	6100147
1	QUICK 1 key-operated selector for outdoor use	JA31101-15

Material to add in order to get the configuration as per Wiring Diagram

Q.ty	Material description	Code
1	Pair of ORION photocells	JA310
2	Column for photocell	JA325
2	Foundation plate for column	JA328

ACCESSORIES



PLATE
Kit of 6 fixing plates.
110x70x5 mm.

Code **58P0199**



BRACKET
Kit of 6 rear brackets h. 160 mm.

Code **6100253**



PROcoder*

Code **6100335**



BATTERY KIT
With recharging board.
Only for 24V models

Code **390923**

CONTROL BOARDS

Brain 17	Page 64
Brain 592	Page 64
Brain 15	Page 65

*To be used with Brain 15 or Brain 17 electronic control boards.



MOTOR WITH ARTICULATED ARM FOR SWING GATES

- Available version: 24V
- Leaves up to 2.5 m
- Equipped with ENV function (Virtual Nominal Encoder)
- G-WAY system (with Brain 06 Control Board)
- Rotary release system and access with customised key
- Sturdy inner kinematic mechanism made of a bronze crown and steel worm-screw
- Integrated adjustable mechanical limit switches
- It allows installation on large pillars.

Code	Name	Version	Voltage	Leaf max. length	Use
6170135	Compas 24	Non-reversible	24V	2.5 m.	Residential
6170136	Compas 24 C	Non-reversible with control board Brain 06	24V	2.5 m.	Residential

OPERATOR DIMENSIONS



Technical Specifications	Compas 24	Compas 24 C
Power supply (V)		230
Electric motor (V)		24
Nominal power (W)	120	140
Max. torque (Nm)		250
Angular speed (°/sec)		13
Leaf max. weight (Kg) ¹		310
Max. continuous cycles		30
Frequency of use at 20 °C		continuous
Operating ambient temperature (°C)		20 +55
Protection class		IP44
Weight (kg)	7	8,7

N.B.

1 - The max. weight of the leaf depends on length: max 200 Kg for 2.50 m; max. 310 Kg for 1.00 m.
Over 2 m, an electric lock is essential to ensure leaf blocking.

ELECTRIC WIRING DIAGRAM

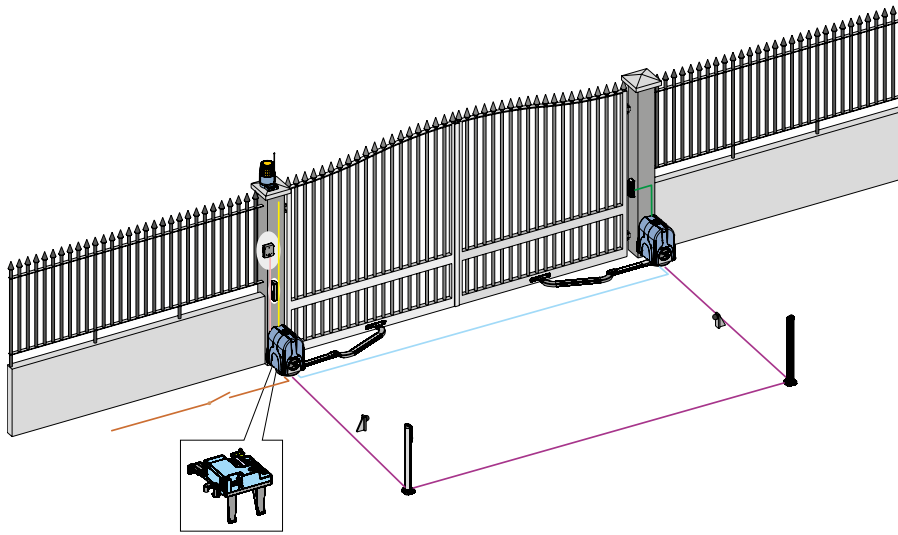

- Line3x1,5 mm²
- Motor*2x2,5 mm²
- Flashing lamp2x1,5 mm²
- Selector2x0,5 mm²
- BUS connection2x0,5 mm²

* Max. distance between motor and control unit 10 m.

TYPICAL INSTALLATION EXAMPLE

Q.ty	Material description	Part number
1	COMPAS 24 C Motor (including control board and articulated arm)	6170136
1	COMPAS 24 Motor (including articulated arm)	6170135
1	433 MHz Frequency Module	6100346
1	Four-Channel Transmitter ECHO TX4 RC	6100334
1	24V GUARD Flashing Lamp	6100054
1	Pair of VEGA BUS Photocells	6100148
1	QUICK 1 key-operated selector for outdoor use	JA31101-15

Material to add in order to get the configuration as per Wiring Diagram

Q.ty	Material description	Part number
1	Pair of VEGA BUS Photocells	6100148
2	Column for photocell	6100149
2	Foundation plate for column	6100150

ACCESSORIES



RADIOFREQUENCY MODULE
RFQZ 3PIN for GENIUS.
433 MHz

Code **6100346**



BATTERY KIT
With recharging board.

Code **390923**



ARM02 KEY-OPERATED SELECTOR WITH LEVER RELEASE

Code **6100340**



RELEASE KIT
To be combined with ARM02

Code **424001**

CONTROL BOARDS

Brain 15 Page 65

868 MHz
Code **6100347**

Trigon 02



G-WAY
BUS

ENV
PATENT



MOTOR FOR SWING GATES

- Leaves up to 3 m
- Release with customised key
- Sturdy inner kinematic mechanism made of a bronze crown and steel worm-screw
- G-WAY system (with Brain 17 and Brain 15 control boards)
- Transmission arm designed to prevent shearing
- Available versions 230V and 24V
- Opening and closing slow down available in both versions
- It allows installation on large pillars.

Code	Name	Version	Voltage	Leaf max. length	Use
6170150	Trigon 02	Non-reversible (arm included)	230V	3 m.	Residential
6170151	Trigon 02-24	Not-reversible (arm included)	24V	3 m.	Residential

OPERATOR DIMENSIONS

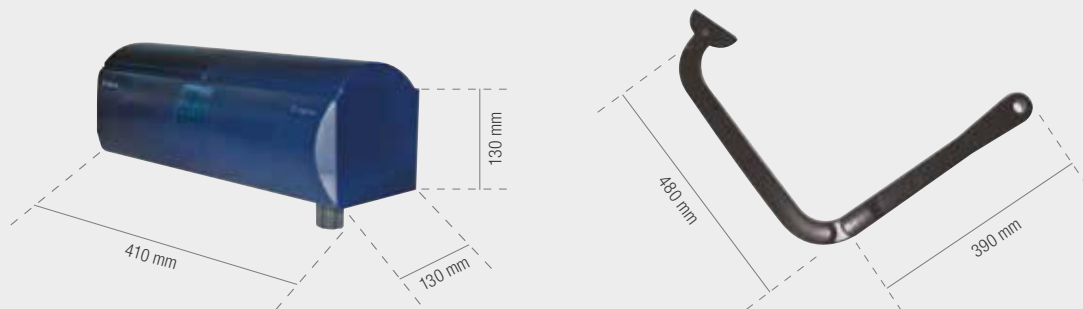

Technical Specifications	Trigon 02	Trigon 02 - 24
Power supply (V)	230	
Electric motor (V)	230	24
Nominal power (W)	280	40
Current (A)	1.2	2
Thermal Protection (°C)	140	-
Capacitor (µF)	8	-
Max. torque (Nm)	250	200
Angular speed (°/sec)	8	
Leaf opening time at 90° (sec.) ¹	18	
Frequency of use at 20 °C	S3 - 30%	continuous
Operating ambient temperature (°C)	-20 +55	
Protection class	IP44	
Weight (kg)	11.5	

CONTROL BOARDS

Brain 17	Page 64
Brain 592	Page 64
Brain 15	Page 65

N.B.

¹ - Opening time and max. leaf dimensions calculated for correctly executed installations at the dimensions indicated in the installation instructions and without slow-downs. Over 2 m, an electric lock is essential to ensure leaf blocking.

ELECTRIC WIRING DIAGRAM

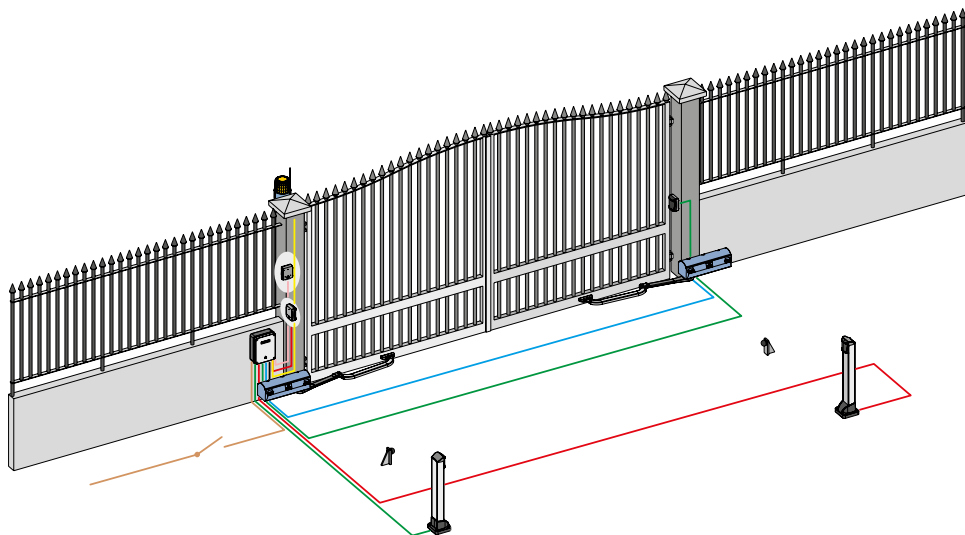

- Line3x1,5 mm²
- Motor*4x1,5 mm²
- Flashing lamp2x1,5 mm²
- Selector2x0,5 mm²
- TX photocells2x0,5 mm²
- RX photocells4x0,5 mm²

* For 24Vdc motors, use 2x2.5 mm² cables - max. distance between motor and control unit 10 m.

TYPICAL INSTALLATION EXAMPLE

Q.ty	Material description	Part number
2	TRIGON O2 Motors	6170150
1	Electronic Control Board BRAIN 17	6100304
1	Electronic Control Board Enclosure	JA320
1	RQFZ 868 MHz Frequency Module	6100347
1	Four-Channel Transmitter KILO TX2 JLC	6100332
1	230V GUARD Flashing Lamp	6100052
1	VEGA Photocells	6100147
1	QUICK 1 key-operated selector for outdoor use	JA31101-15

Material to add in order to get the configuration as per Wiring Diagram

Q.ty	Material description	Part number
1	Pair of ORION photocells	JA310
2	Column for photocell	JA325
2	Foundation plate for column	JA328

ACCESSORIES



LIMIT SWITCH
For motor closing or opening limit stop.

Code **390682**



BATTERY KIT
With recharging board.
Only for 24V models

Code **390923**



Patented lever-operated manual release system which enables manual operation both from the inside and from the outside of the property (supplied with the box)

Underground motor for swing gates

- Fully hidden and extremely compact non-reversible gearmotor.
- Single version for openings up to 180°, as standard.
- Designed to operate leaves with max. weight of 250 kg and up to 2.5 width.
- Absolute encoder (optional) which detects leaf position and ensures maximum anti-crushing safety.
- Virtual patented Encoder system via BUS G-WAY bus (with Brain 15 control board).
- Adjustable mechanical stops (optional).

Code	Name	Version	Voltage	Leaf max. length	Use
6170082	Diablo	Non-reversible	24V	2.5 m.	Residential

OPERATOR DIMENSIONS

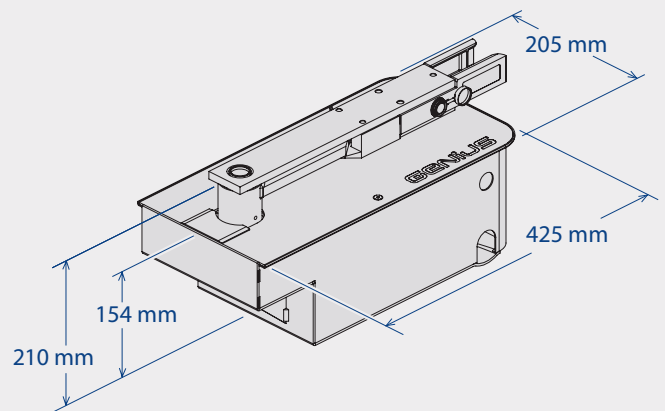

Technical Specifications	Diablo
Power supply (V)	230
Electric motor (V)	24
Nominal power (W)	140
Max. torque (Nm)	200
Rated torque (Nm)	130
Angular speed (°/sec)	6
Frequency of use at 20 °C	continuous
Operating ambient temperature (°C)	-20 +55
Protection class	IP67
Weight (kg)	6.5

CONTROL BOARDS

Brain 15

Page 65

N.B.

Over 1.8 m, an electric lock is essential to ensure leaf blocking.

ELECTRIC WIRING DIAGRAM

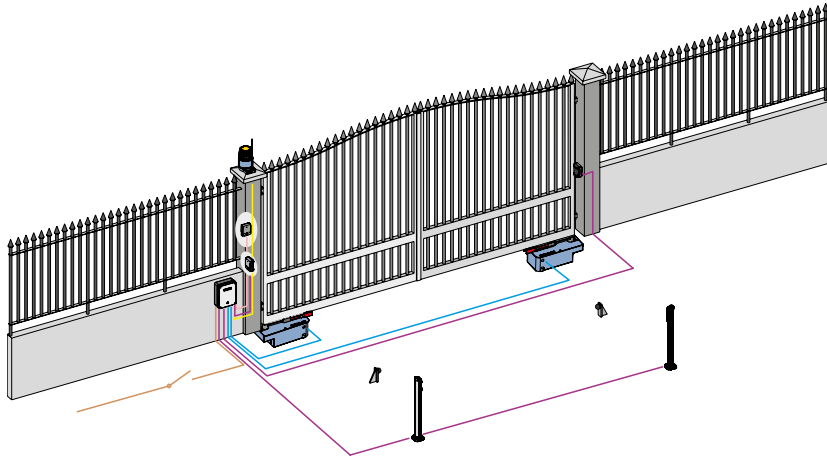

- Line3x1,5 mm²
- Motor*2x2,5 mm²
- Flashing lamp2x1,5 mm²
- Selector2x0,5 mm²
- BUS connection2x0,5 mm²

* For 24Vdc motors, use 2x2.5 mm² cables - max. distance between motor and control unit 10 m

TYPICAL INSTALLATION EXAMPLE

Q.ty	Material description	Part number
2	DIABLO Motors	6170082
1	Electronic Control Board BRAIN 15	6100263
2	DIABLO bearing boxes with 180° release system	6100319
1	RQFZ 868 MHz Frequency Module	6100347
1	Four-Channel Transmitter KILO TX2 JLC	6100332
1	24V GUARD Flashing Lamp	6100054
1	Pair of VEGA BUS Photocells	6100148
1	QUICK 1 key-operated selector for outdoor use	JA31101-15

Material to add in order to get the configuration as per Wiring Diagram

Q.ty	Material description	Part number
1	Pair of VEGA BUS Photocells	6100148
2	Column for photocell	6100149
2	Foundation plate for column	6100150

ACCESSORIES



DIABLO FOUNDATION BOX WITH RELEASE SYSTEM

Max. opening angle up to 180°.

Code **6100319**



MECHANICAL STOP KIT
In order to avoid the use of on-ground mechanical stops.

Code **6100320**



ABSOLUTE ENCODER KIT
Consisting of Encoder and relevant support to constantly detect the position of the leaf.

Code **6100321**



BATTERY KIT
With recharging board.

Code **390923**

Roller



G-WAY
BUS

ENV
PATENT



Polyester painting also suitable for installation in salty environment

MOTOR FOR SWING GATES

- Leaves up to 3.5 m and max 500 Kg each leaf
- G-WAY System (with Brain 15 and Brain 17 control boards)
- PROcoder Safety System (with Brain 15 and Brain 17 control boards)
- Release through a user friendly accessory lever and customised key - **PATENTED**
- Three mechanical reduction phases with steel worm-screw
- Opening and closing slow down available in both versions
- Double painting layer motor
- 3 different foundation casing models
- Kit for opening to 140° and 180°
- Optional mechanical leaf stop in opening and closing.

Code	Name	Version	Voltage	Leaf max. length	Use
6170077	Roller	Non-reversible	230V	3.5 m.	Residential
6170080	Roller 24	Non-reversible	24V	3.5 m.	Residential

OPERATOR DIMENSIONS

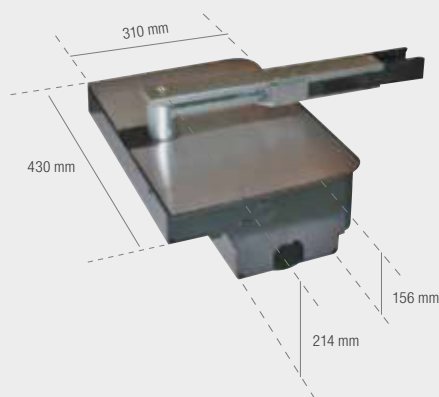

Technical Specifications	Roller	Roller 24
Power supply (V)		230
Electric motor (V)	230	24
Nominal power (W)	380	70
Current (A)	1.7	3
Capacitor (µF)	12,5	-
Max. torque (Nm)	330	300
Angular speed (°/sec)		6
Leaf opening time at 90° (sec.) ¹	18 (110°/180°)-10.5 (140°)	
Frequency of use at 20 °C	S3 - 30%	continuous
Operating ambient temperature (°C)	-20 +55	
Protection class	IP67	
Weight (kg)	26,5	

CONTROL BOARDS

Brain 17	Page 64
Brain 592	Page 64
Brain 15	Page 65

N.B.

¹ - Opening time and max. leaf dimensions calculated for correctly executed installations at the dimensions indicated in the installation instructions and without slow-downs. Over 2 m, an electric lock is essential to ensure leaf blocking.

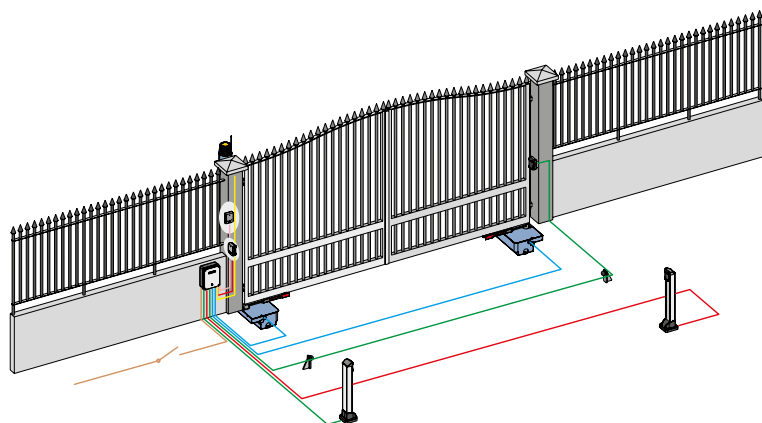

- Line3x1,5 mm²
- Motor*4x1,5 mm²
- Flashing lamp2x1,5 mm²
- Selector2x0,5 mm²
- TX photocells2x0,5 mm²
- RX photocells4x0,5 mm²

* For 24Vdc motors, use 2x2.5 mm² cables - max. distance between motor and control unit 10 m

TYPICAL INSTALLATION EXAMPLE

Q.ty	Material description	Part number
2	ROLLER Motors	6170077
1	Electronic Control Board BRAIN 592	JA592
1	RC 433 one-channel receiver	6100110
1	Electronic Control Board Enclosure	JA320
1	Four-Channel Transmitter ECHO TX4 JLC	6100334
2	ROLLER BOX bearing boxes	58P0050
2	Release Device with 110° opening key	6100286
1	Single Channel Card Receiver 433 MHz	6100110
1	Four-Channel Transmitter ECHO TX4 TRC	6100334
1	230V GUARD Flashing Lamp	6100052
1	VEGA Photocells	6100147
1	QUICK 1 key-operated selector for outdoor use	JA31101-15

Material to add in order to get the configuration as per Wiring Diagram

Q.ty	Material description	Part number
1	Pair of ORION photocells	JA310
2	Column for photocell	JA325
2	Foundation plate for column	JA328

ACCESSORIES



ROLLER BOX
Foundation box in steel.
Cover in galvanised steel.

Code **58P0050**



ROLLER BOX INOX
Foundation box in stainless steel.
Cover in stainless steel.

Code **58P0052**



RELEASE DEVICE
For 110° opening.
PATENT

Code **6100286**



KIT FOR OPENING TO 140°
To obtain an opening angle of 140°¹

Code **390612**



KIT FOR OPENING TO 180°
To obtain an opening angle of 180°²

Code **490111**



ABSOLUTE ENCODER UNIT³
Gives the exact position of the leaf.

Code **404035**

Cover in stainless steel.

Code **58P0051**



Internal opening mechanical stop
For levers 110°/140°.

Code **722121**



Internal closing mechanical stop
For levers 110°/140°.

Code **722122**



ADAPTER
For installing ROLLER in existing foundation boxes.

Code **58P1573**



BATTERY KIT
With recharging board.
Only for 24V models

Code **390923**

1 - levers to be added to 6100286 to get a 140° opening angle.
2 - gears to be added to 6100286 to get a 180° opening angle.
3 - it can be used for Rollers and Brain 17 board.

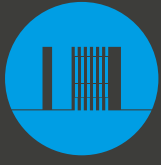

Automated systems for
SLIDING GATES

Selection

GUIDE

Sliding gate

Max. weight 400 Kg

24V

Blizzard 400 C ENC.....Page 36

Max. weight 500 Kg

230V

Blizzard 500 C ENC.....Page 34

Max. weight 900 Kg

230V

Blizzard 900 C ENC.....Page 34

Max. weight 1400 Kg

230V

Falcon M14Page 38

Max. weight 2000 Kg

230V

Falcon M20Page 38

Blizzard 230V



integrated encoder



Simple release device with key (optional)

Die-cast aluminium basement

GEARMOTOR FOR SLIDING GATES

- Available versions: 230V for gates up to 500-900 Kg.
- Sturdy inner kinematic mechanism.
- Magnetic Limit Switches.
- Electronic control board with transparent plastic enclosure and external programming buttons.
- Huge selection of operating logics and working parameters.
- Compact dimensions.
- Big internal space for wiring; easy operator height and depth installation adjustments.

Code	Name	Version	Voltage	Leaf Weight	Use
61100821	Blizzard 500 C ENC	Non-reversible - Sprint 382 on board	230V	500 kg	Residential/Condominium
61100861	Blizzard 900 C ENC	Non-reversible - Sprint 382 on board	230V	900 kg	Residential/Condominium

OPERATOR DIMENSIONS



Technical Specifications	Blizzard 500 C ENC	Blizzard 900 C ENC
Power supply (V)	230	
Electric motor (V)	230	
Nominal power (W)	360	540
Thermal Protection (°C)	140 (self-resetting)	
Capacitor (µF)	10	12,5
Max thrust force (N)	390	590
Type of pinion gear	Z16 mod.4	
Leaf speed (m/min)	12	
Frequency of use at 20°C	S3 - 40%	
Operating ambient temperature (°C)	-20 +55	
Protection class	IP44	
Weight (kg)	9,2	10

CONTROL BOARDS

Sprint 382

Page 65

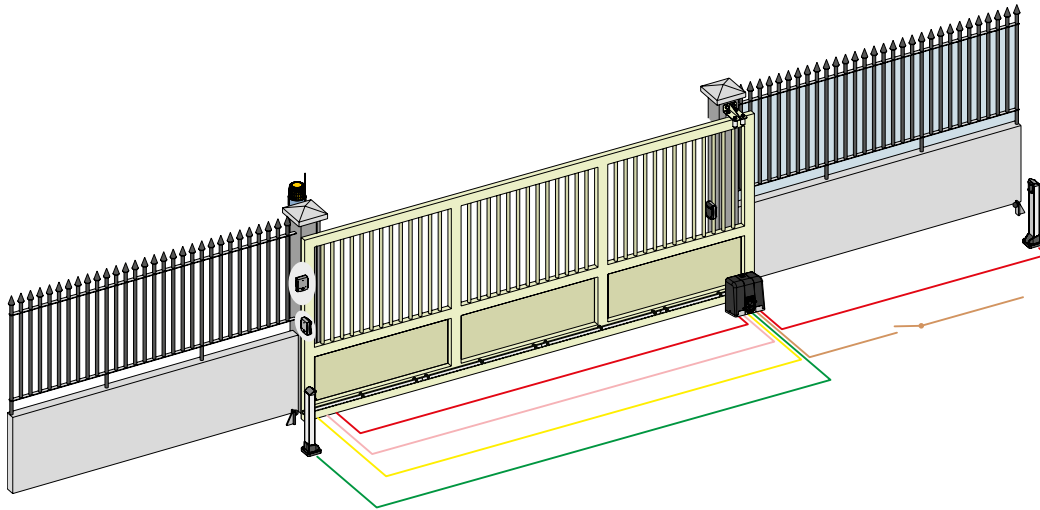

- Line3x1,5 mm²
- Flashing lamp2x1,5 mm²
- Selector2x0,5 mm²
- TX photocells2x0,5 mm²
- RX photocells4x0,5 mm²

TYPICAL INSTALLATION EXAMPLE

Q.ty	Material description	Part number
1	BLIZZARD 500 C ENC Gearmotor with incorporated control board and encoder	61100821
1	Foundation Plate	737000
4 m	Galvanised Rack 30x12 with weld-on fittings	JA146
1	5-PIN one-channel receiver 868 MHz	6100352
1	Two-channels transmitter KILO TX2 JLC	6100332
1	230 V GUARD flashing lamp	6100052
1	VEGA Photocells	6100147
1	QUICK 1 key-operated selector for outdoor use	JA31101-15

Material to add in order to get the configuration as per Wiring Diagram

Q.ty	Material description	Part number
1	Pair of ORION photocells	JA310
2	Column for photocell	JA325
2	Foundation plate for column	JA328

ACCESSORIES



RACK
1 m. in galvanized iron 30 x 12 mm².

Code **JA146**



NYLON RACK WITH STEEL CORE 30X20 MOD.4
pack of 4 pieces, 1 m ea.

Code **6100344**



SPACERS
Kit of 3 spacers and M8x30 screw-on fastening screws for 1 meters of iron rack²

Code **JA147**



SPACERS
Kit of 3 spacers and M8x50 screw-on fastening screws for 1 meters of iron rack²

Code **JA148**



SCREWS
Kit screw-in fastening screws for 1m of rack - 4 kit pieces (to be combined with code 6100344)

Code **6100345**



LOCK
Lock with personalized key

Code **424413**



FOUNDATION PLATE

Code **737000**



ADAPTER PLATE BLIZZARD-MILORD

Code **737001**



ADAPTER PLATE BLIZZARD - FALCON

Code **737003**

1 - 6 m package.
2 - 6 kits package.

Blizzard 24V



integrated encoder



Simple release device with key (optional)

Die-cast aluminium basement

GEARMOTOR FOR SLIDING GATES

- Available versions for gates up to 400 kg.
- Complete movement control and effective reverse on obstacle response.
- Magnetic Limit Switches.
- Electronic control board with transparent plastic enclosure and external programming buttons.
- Huge selection of operating logics and working parameters.
- Compact dimensions.
- Big internal space for wiring; easy operator height and depth installation adjustments.

Code	Name	Version	Voltage	Leaf Weight	Use
6110080	BLIZZARD 400 C ENC	Non-reversible - Sprint M24 on board	24V	400 kg	Residential/Condominium

OPERATOR DIMENSIONS



Technical Specifications	Blizzard 400 C ENC
Power supply (V)	230
Electric motor (V)	24
Nominal power (W)	140
Max thrust force (N)	310
Type of pinion gear	Z16 mod.4
Leaf speed (m/min)	12
Use frequency	Continuous
Operating ambient temperature (°C)	-20 +55
Protection class	IP44
Weight (kg)	7

CONTROL BOARDS

Sprint M24

Page 66

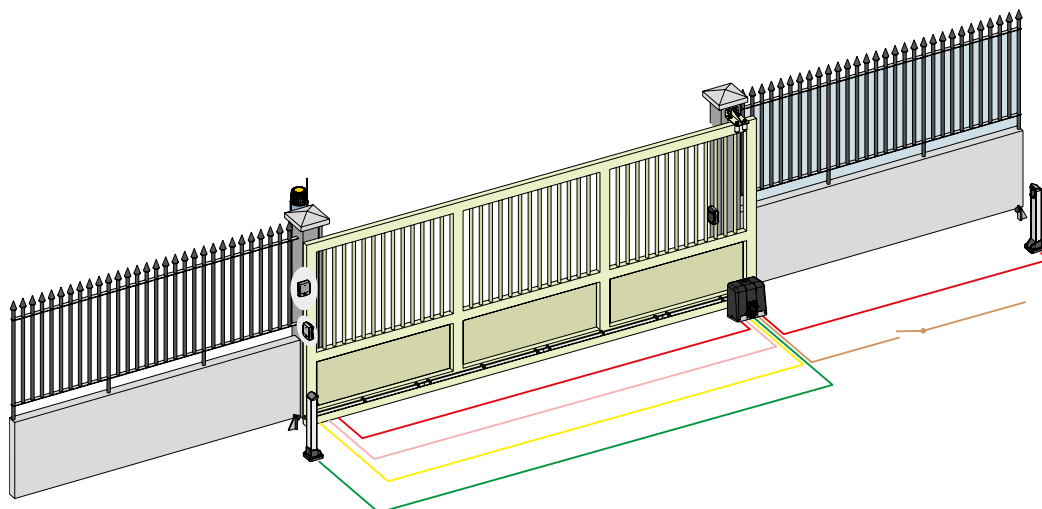

- Line3x1,5 mm²
- Flashing lamp2x1,5 mm²
- Selector2x0,5 mm²
- TX photocells2x0,5 mm²
- RX photocells4x0,5 mm²

TYPICAL INSTALLATION EXAMPLE

Q.ty	Material description	Part number
1	BLIZZARD 400 C ENC Gearmotor with incorporated control board and encoder	6110080
1	Foundation Plate	737000
4 m	Galvanised Rack 30x12 with weld-on fittings	JA146
1	RQFZ 868 MHz Frequency Module	6100347
1	Two-channels transmitter KILO TX2 JLC	6100332
1	230 V GUARD flashing lamp	6100052
1	Pair of VEGA BUS Photocells	6100148
1	QUICK 1 key-operated selector for outdoor use	JA31101-15

Material to add in order to get the configuration as per Wiring Diagram

Q.ty	Material description	Part number
1	Pair of ORION photocells	JA310
2	Column for photocell	JA325
2	Foundation plate for column	JA328

ACCESSORIES



RACK
1 m. in galvanized iron 30 x 12 mm².

Code **JA146**



NYLON RACK WITH STEEL CORE 30X20 MOD.4
pack of 4 pieces, 1 m ea.

Code **6100344**



SPACERS
Kit of 3 spacers and M8x30 screw-on fastening screws for 1 meters of iron rack²

Code **JA147**



SPACERS
Kit of 3 spacers and M8x50 screw-on fastening screws for 1 meters of iron rack²

Code **JA148**



SCREWS
Kit screw-in fastening screws for 1m of rack - 4 kit pieces (to be combined with code 6100344)

Code **6100345**



LOCK
Lock with personalized key

Code **424413**



FOUNDATION PLATE

Code **737000**



ADAPTER PLATE BLIZZARD-MILORD

Code **737001**

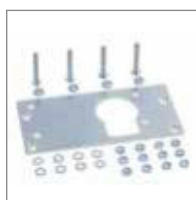

ADAPTER PLATE BLIZZARD - FALCON

Code **737003**



BATTERY KIT
With recharging board.

Code **390923**

1 - 6 m package.
2 - 6 kits package.

Falcon M14 - M20



Gearmotor body in aluminium painted with polyester powders and protective housing in ABS

Magnetic limit switch entirely protected

GEARMOTOR FOR SLIDING GATES

- Available version: 230V for gates up to 1400 - 2000 Kg
- Optional Encoder installation for obstacle detection
- Sturdy inner kinematic mechanism made of a bronze crown and steel worm-screw
- Magnetic Limit Switches
- Electronic Control Board with Transparent plastic Enclosure and external programming buttons
- Rotating Panel for easier programming
- Gearmotor body painted with polyester powder.
- User friendly release system protected by personalized key.

Code	Name	Version	Voltage	Leaf Weight	Use
6110002	Falcon M14 C	Non-reversible - integrated Sprint 382	230V	1400 kg	Industrial
6110022	Falcon M20 C	Non-reversible - integrated Sprint 382	230V	2000 kg	Industrial

OPERATOR DIMENSIONS



Technical Specifications	Falcon M14	Falcon M20
Power supply (V)	230	
Electric motor (V)	230	
Nominal power (W)	650	800
Current (A)	2.80	3.5
Thermal Protection (°C)	140	
Capacitor (µF)	16	20
Max. torque (Nm)	35	45
Thrust on pinion (daN)	110	150
Type of pinion gear	Z16 mod. 4	
Angular speed (m./min.)	10	
Frequency of use at 20 °C	S3 - 40%	
Operating ambient temperature (°C)	-20 +55	
Protection class	IP44	
Weight (kg)	14	15

CONTROL BOARDS

Sprint 382

Page 65

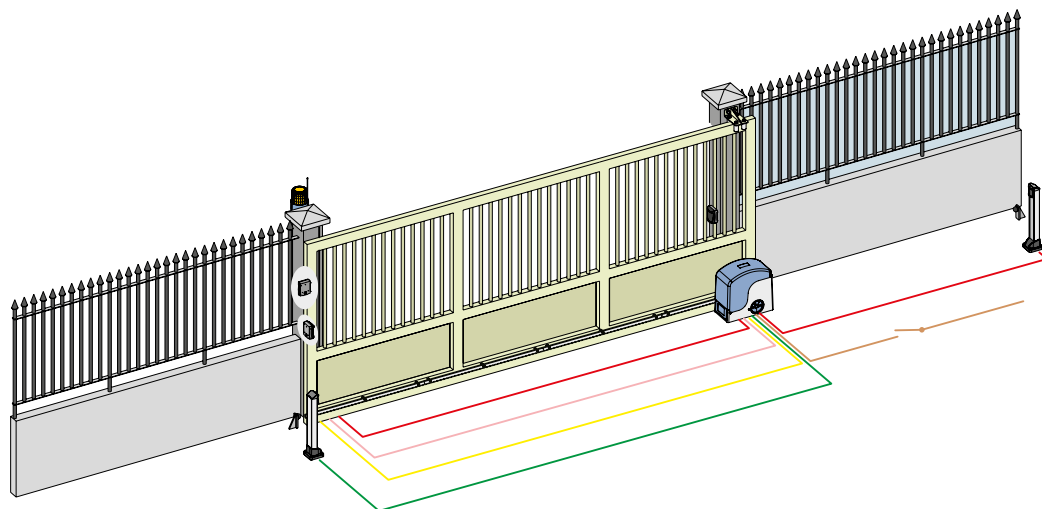

- Line3x1,5 mm²
- Flashing lamp2x1,5 mm²
- Selector2x0,5 mm²
- TX photocells2x0,5 mm²
- RX photocells4x0,5 mm²

TYPICAL INSTALLATION EXAMPLE

Q.ty	Material description	Part number
1	FALCON M14C Gearmotor with incorporated control board and foundation plate	6110002
4 m	Galvanised Rack 30x12 with weld-on fittings	JA146
1	5-PIN one-channel receiver 868 MHz	6100352
1	Four-Channel Transmitter KILO TX2 JLC	6100332
1	230V GUARD Flashing Lamp	6100052
1	VEGA Photocells	6100147
1	QUICK 1 key-operated selector for outdoor use	JA31101-15

Material to add in order to get the configuration as per Wiring Diagram

Q.ty	Description	Part number
1	Pair of ORION photocells	JA310
2	Column for photocell	JA325
2	Foundation plate for column	JA328

ACCESSORIES



RACK
1 m. in galvanised iron 30 x 12 mm¹.

Code **JA146**



SPACERS
Kit of 3 spacers and M8x30 screw-on fastening screws for 1 meters of iron rack²

Code **JA147**



SPACERS
Kit of 3 spacers and M8x50 screw-on fastening screws for 1 meters of iron rack²

Code **JA148**



ENCODER
Grants a more precise motor control and enables a reactive reverse on obstacle

Code **6100013**

1 - 6 m package.
2 - 6 kits package.



Automated systems for
garage **DOORS** e **ROLLING SHUTTERS**

Selection

GUIDE

Up-and-over Garage Doors

Door (bxh) 3.3 x 3 m

230V

Euro Breeze 06 Page 42

Door (bxh) 5 x 2.5 m

24V

Zodiac 60 Page 44

Door (bxh) 5 x 3.1 m

24V

Zodiac 100 Page 44

Rolling shutters

Max. weight 250 Kg

230V

Shutter 15 Page 46

Max. weight 270 Kg

230V

Shutter 20 Page 46

Max. weight 430 Kg

230V

Shutter B 40 Page 46

Euro Breeze 06



integrated encoder

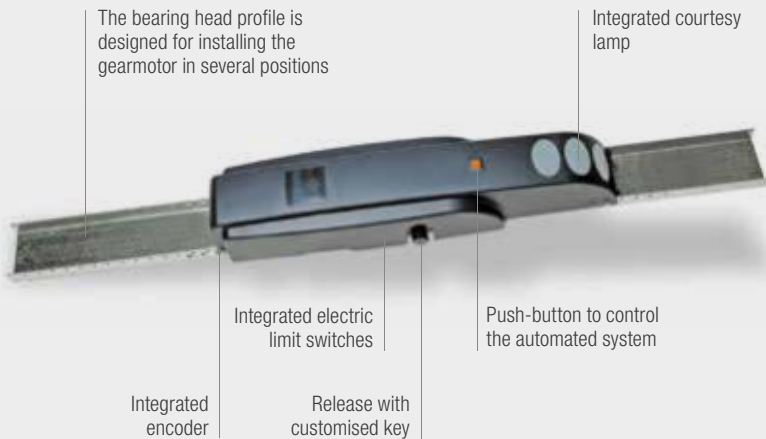

MOTOR FOR UP-AND-OVER DOORS AND COUNTER-WEIGHTS

- Available version 230V for single door up to 10m² and in double applications up to 15m².
- Pre-drilled mounting head section for assembling the motor in different positions.
- Integrated courtesy lamp.
- Integrated push-button to control the automated system.
- Motor release system through customised key to be ordered separately.
- Available version: with integrated electronic control board, encoder and limit switches

Code	Name	Version	Voltage	Max. door (bxh)	Use
6120045	Euro Breeze 06 Sb/LH	Non-reversible	230V	3.3 x 3 m.*	Residential
6120036	Euro Breeze 06 C Sb/RH	Non-reversible -integrated Geo 07 control board	230V	3.3 x 3 m.*	Residential

* 5 x 3 m. with 2 motors.

OPERATOR DIMENSIONS

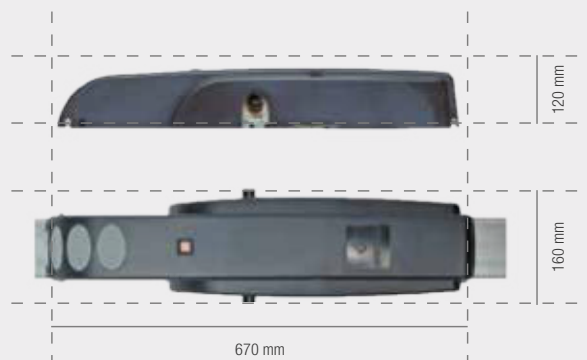

Technical Specifications	Euro Breeze 06
Power supply (V)	230
Electric motor (V)	230
Power (W)	350
Current (A)	1.5
Thermal Protection (°C)	140
Capacitor (µF)	10
Max. torque (Nm)	300
Angular speed (°/sec)	12
Opening time at 90° (sec.) ¹	15
Frequency of use at 20 °C	S3 - 30%
Indicative hour cycles at 20°C	≥36
Operating ambient temperature (°C)	20 +55
Operator weight (Kg)	7.5
Protection class ²	IP44

CONTROL BOARDS

Geo 07

Page 67

N.B.

- 1 - Opening time and max. door dimensions calculated for correctly executed installations at the dimensions indicated in the installation instructions and without slow-downs.
- 2 - Gearmotor has to be considered as IP44 when the IP44 kit for control board code 110554 is used.

ELECTRIC WIRING DIAGRAM

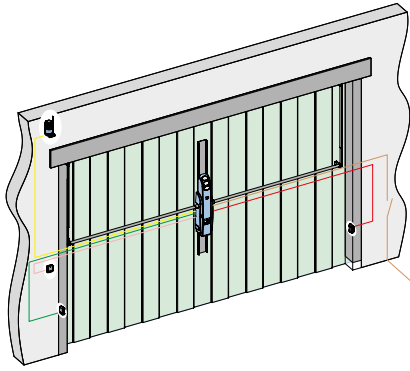

- Line3x1,5 mm²
- Flashing lamp2x1,5 mm²
- Selector2x0,5 mm²
- TX photocells2x0,5 mm²
- RX photocells4x0,5 mm²

TYPICAL INSTALLATION EXAMPLE

Q.ty	Material description	Part number
1	EURO BREEZE 06 C motor with incorporated control board	6120036
1	Head Profile length 1.5 m.	58P0584
1	Package of straight arms	738709
1	Pair of transmission tubes	58P0380
1	Key-operated external release	390607
1	5-PIN one-channel receiver 868 MHz	6100352
1	Four-Channel Transmitter KILO TX2 JLC	6100332
TOTAL (VAT EXCLUDED)		

Material to add in order to get the configuration as per Wiring Diagram

Q.ty	Material description	Part number
1	QUICK 1 key-operated selector for outdoor use	JA31101-15
1	230V GUARD Flashing Lamp	6100052

ACCESSORIES



EXTERNAL RELEASE
For application to existing handle

Code **390607**



BUSHES
Set of 6 grooved bushes.

Code **58P0371**



PUSH-BUTTONS
6 push-buttons for up-and over door.

Code **58P2015**



TRANSMISSION TUBES
2 galvanised tubes for side application.
Length 200 mm.

Code **58P0379**



TRANSMISSION TUBES
2 galvanised tubes for central application.
Length 1500 mm.

Code **58P0380**



KEY OPERATED PLUG
For external release system door thickness up to 45 mm.

Code **6100015**



HEAD PROFILES
Length 2000 mm.

Code **58P0587**



KIT OF 2 CURVED ARMS
With brackets to be welded.

Code **6100127**



KIT OF 2 STRAIGHT ARMS
With brackets to be welded.

Code **58P0392**

Length 2050 mm.
Code **58P0381**

Door thickness up to 45 mm.
Code **6100014**

Length 1500 mm.
Code **58P0584**

Length 1300 mm.
Code **58P0583**

Length 700 mm.
Code **6100264**

ARMS TO BE WELDED

ARMS TO BE SCREWED



KIT WITH 2 STRAIGHT TELESCOPIC ARMS
With bush not to be welded.

Code **738709**



KIT OF 2 STRAIGHT ARMS
With grooved welded bush. For side applications with 2 motors.

Code **58P0386**



Basis made of sturdy plastic material which reduces weight and enhances handiness

SPRING UP-AND-OVER MOTOR, SECTIONAL AND COUNTERWEIGHTS DOOR OPERATOR

- Available version: 24V with 600N thrust (Zodiac 60) and 1000N (Zodiac 100)
- PATENTED three steps driving rail assembly
- Standard supplied with power cable and plug.
- Arranged for Low-consumption lamps
- Integrated courtesy lamp
- Easy Access to Programming Panel, no need to open the motor lid
- Integrated push-button to control opening.

Code	Name	Version	Voltage	Max. sectional door (bxh)*	Max. up-and-over door (bxh)*
6120041	Zodiac 60	Non-reversible - 600 N thrust - Geo 08 on board	24V	5 X 2.50 m.	3 X 2.50 m.
6120042	Zodiac 100	Non-reversible - 1000 N thrust - Geo 09 on board	24V	5 X 3.10 m.	3 X 3.10 m.

* Maximum height depends on the door geometry. The indicated values refer to traditional configurations.

OPERATOR DIMENSIONS

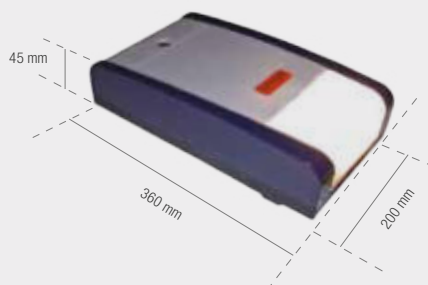

Technical Specifications	Zodiac 60	Zodiac 100
Power supply (V)	230	
Electric motor (V)	24	
Power (W)	220	350
Thrust (daN)	600	600/1000
Max. consecutive cycles	30	
Max. carriage travel (mm.)	1900 - 2500 - 3100	
Carriage speed, load free (m/min.)	6.6	
Frequency of use at 20 °C	80 cycles per day	
Operating ambient temperature (°C)	-20 +55	
Operator weight (Kg)	6.6	
Protection class	IP20	

CONTROL BOARDS

Geo 08 Page 68
Geo 09 Page 68

ELECTRIC WIRING DIAGRAM

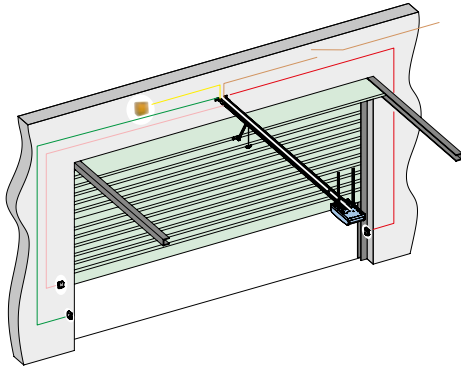

- Line3x1,5 mm²
- Flashing lamp2x1,5 mm²
- Selector2x0,5 mm²
- TX photocells2x0,5 mm²
- RX photocells4x0,5 mm²

TYPICAL INSTALLATION EXAMPLE

Q.ty	Material description	Part number
1	ZODIAC 60 Motor	6120041
1	Single chain rail, travel 1900 m	6100059
1	Cable for external release (application on existing handle)	390488
1	RQFZ 868 MHz Frequency Module	6100347
1	Four-Channel Transmitter KILO TX2 JLC	6100332

Material to add in order to get the configuration as per Wiring Diagram

Q.ty	Material description	Part number
1	QUICK 1 key-operated selector for outdoor use	JA31101-15
1	VEGA Photocells	6100147
1	LEDDY 24V Lamp	6100190

ACCESSORIES



BATTERY KIT
With recharging board.

Code **390923**



LEDDY
24 Vdc with integrated flashing.

Code **6100190**

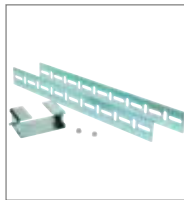

RAIL CENTRAL SUPPORT
Single rail

Code **390765**



EXTERNAL RELEASE
Cable for external release, with application on existing handle for sectional doors.
In pairing with adapter arm for up-and-over doors with counter-weights, use the external release.
Code 58P0398 on page 43

Code **390488**



CABLE RELEASE KIT
External release kit with 1.5 m Bowden cable, cable stopper and cylinder with coded key.

Code **6100285**



RADIOFREQUENCY MODULE
RQFZ 3PIN for GENIUS.
433 MHz

Code **6100346**



ARM FOR SECTIONAL DOORS
Arm for sectional doors.

Code **390768**



ADAPTER ARM
For up-and-over doors with counter-weights of max. height 2400 mm.

Code **6100156**



CHAIN/BELT RAILS*



ARMO2 KEY-OPERATED SELECTOR WITH LEVER RELEASE

Code **6100340**

Rail type	Description*	Code
G 1900 - 1B	With belt, travel 1900 mm 1 piece	390120
G 2500 - 1B	With belt, travel 2500 mm 1 piece	390126
G 3100 - 1B	With belt, travel 3100 mm 1 piece	390132
G 2500 - 2B	With belt, travel 2500 mm 2 pieces	390226
G 3100 - 2B	With belt, travel 3100 mm 2 pieces	390232

*N.B. The indicated measures correspond to effective carriage travel. The rail overall dimensions (including motor) are 900 mm over the travel for Zenith and 870 mm over the travel for Zodiac.

Shutter



OPERATOR FOR SHUTTERS

- It does not need any maintenance at all, it is low silent and quick to install
- The manual release acts directly on the gearing, with the advantage of making the shutter lighter to move
- Semi-automatic, micrometric control of the limit switch

Code	Name	Version	Voltage	crown wheel \varnothing	\varnothing supporting pole	Lifting capacity
6140003	Shutter 15 R	Reversible	230V	200 ¹	60 ²	170 kg
6140004	Shutter 15	Non-reversible with electromagnetic brake	230V	200 ¹	60 ²	170 kg
6140009	Shutter 20 R	Reversible	230V	240	76	280 kg
6140010	Shutter 20	Non-reversible with electromagnetic brake	230V	240	76	260 kg
6140005	Shutter B 40	Two motors, irreversible with electromagnetic brake	230V	240	76	360 kg

OPERATOR DIMENSIONS

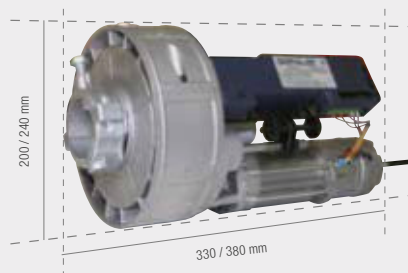

Technical Specifications	15 (200/60)		15 R (200/60)		20 (240/76)	20 R (240/76)	B 40 (240/76)
Power supply (V)	230/115				230		
Electric motor (V)	230						
Frequency (Hz)	50	60	50	60	50		
Torque (Nm)	170				280		400
Power (W)	630	610	630	610	1260		
Absorbed current (A)	2.7	5.2	2.7	5.2	5.4		
Max. work time (Min.)	4						
Max. rolling shutter height	6						
Operating ambient temperature (°C)	-20 +55						

N.B.

- 1 - The crown wheel diameter can be of 220 mm using the relevant plastic clamp included in the package of the Shutter 15 models.
- 2 - To be used also with supporting poles \varnothing 48mm, \varnothing 42mm or \varnothing 33mm adding the optional adapters in the next page.

ELECTRIC WIRING DIAGRAM

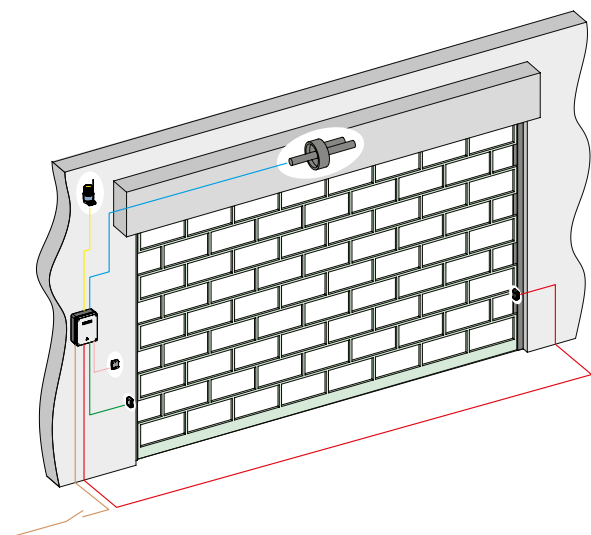

- Line3x1,5 mm²
- Motor4x1,5 mm²
- Flashing lamp2x1,5 mm²
- Selector2x0,5 mm²
- TX photocells2x0,5 mm²
- RX photocells4x0,5 mm²

TYPICAL INSTALLATION EXAMPLE

Q.ty	Material description	Part number
1	SHUTTER 15 R gearmotor	6140003
1	Electro-brake for SHUTTER 15 R	6100247
1	GEO 13 control board with "step-by-step" logic	6100306
1	Electronic Control Board Enclosure	6100140
1	ARMO2 key-operated selector with lever release	6100340

Material to add in order to get the configuration as per Wiring Diagram

Q.ty	Material description	Part number
1	VEGA Photocells	6100147
1	230V GUARD Flashing Lamp	6100052

ACCESSORIES



ARMO2 KEY-OPERATED
SELECTOR WITH LEVER
RELEASE

Code **6100340**



ELECTROMAGNETIC
BRAKE KIT

Code **391450**



ADAPTERS FOR
SUPPORTING POLE
Adapter for 60/33 tube
For Shutter 15

Code **6100273**

Shaft adapters 60 > 48/42 mm

Code **391452**

for 60/48 tube

Code **6100275**

CONTROL BOARDS

Geo 13

Page 68



Automated systems for
industrial **DOORS**

Selection

GUIDE

Industrial closing

Door (bxh) 3 x 5 m

230V	
Trigon K	Page 50
24V	
Trigon K 24	Page 50

Trigon K



G-WAY
BUS

ENV
PATENT



GEARMOTOR FOR FOLDING DOORS

- Rotation of the output pin combined with a telescopic arm moves the door, ensuring it locks at closure.
- Patented virtual encoder and G-WAY Bus (with Brain 15 control board or Brain 17).
- The electrical limit-switches at opening and closing (optional), with simple adjustment facility are easy to install.
- The release system with customised key enables the door to be moved by hand, also in case of a power cut.
- For application on large folding doors with two panels, up to 3m in width and max. height of 5 m.

Code	Name	Version	Voltage	Max. door (bxh)
6170152	Trigon K	Non-reversible	230V	3 X 5 m.
6170153	Trigon K - 24	Non-reversible	24V	3 X 5 m.

OPERATOR DIMENSIONS

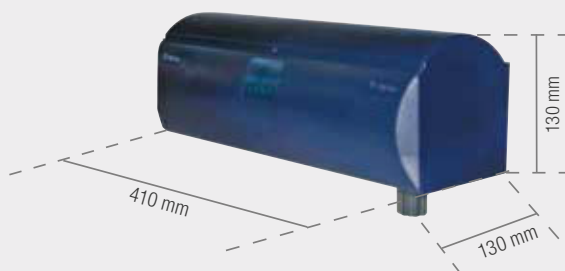

Technical Specifications	Trigon K	Trigon K - 24
Power supply (V)	230	
Electric motor (V)	230	24
Power (W)	280	40
Current (A)	1.2	2
Thermal Protection (°C)	140	-
Capacitor (µF)	8	-
Angular speed (°/sec)	8	-
Frequency of use at 20 °C	S3 - 30%	100%
Shaft rated torque (Nm)	250	200
Operating ambient temperature (°C)	-20 +55	
Gearmotor weight (kg)	11.5	
Protection class	IP44	

CONTROL BOARDS

Brain 17	Page 64
Brain 592	Page 64
Brain 15	Page 65

ELECTRIC WIRING DIAGRAM

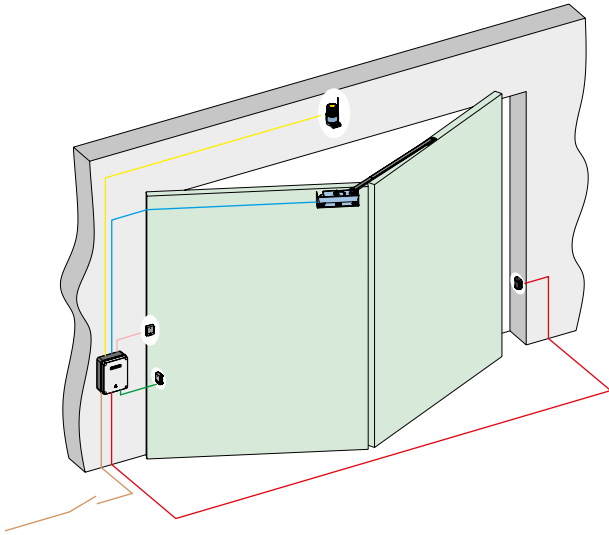

- Line3x1,5 mm²
- Motor*4x1,5 mm²
- Flashing lamp2x1,5 mm²
- Selector2x0,5 mm²
- TX photocells2x0,5 mm²
- RX photocells4x0,5 mm²

* For 24Vdc motors, use 2x2.5 mm² cables - max. distance between motor and control unit 10 m

TYPICAL INSTALLATION EXAMPLE

Q.ty	Material description	Part number
1	Trigon K motor	6170152
1	Telescopic arm	00058P0656
1	Electronic Control Board BRAIN 17	6100304
1	RQFZ 868 MHz Frequency Module	6100347
1	Four-Channel Transmitter KILO TX2 JLC	6100332
1	230V GUARD Flashing Lamp	6100052
1	VEGA Photocells	6100147
1	QUICK 1 key-operated selector for outdoor use	JA31101-15

ACCESSORIES



LIMIT SWITCH
For motor closing or opening limit stop.

Code **390682**



ARM
Folding door telescopic arm kit.

Code **58P0656**



INTERNAL RELEASE KIT
Internal release kit for folding door with 5 m cable and release knob.

Code **58P0658**



EXTERNAL RELEASE KIT
External release kit for leaf door and folding gate with 5 m cable. N.B. Kit to be assembled together with safety enclosure.

Code **58P0659**



BATTERY KIT
With recharging board.
Only for 24V models

Code **390923**



Automatic BARRIERS

Selection

GUIDE

Barrier

Residential / Condominium

230V

Max. beam length 3 m	
Spin 3C ENC	Page 54
Max. beam length 5 m	
Spin 4C ENC	Page 54
Max. beam length 7 m	
Spin 6C ENC	Page 54

Condominium / Industrial

24V

Max. beam length 3 m	
Rainbow Fast 324 C	Page 57
Max. beam length 5 m	
Rainbow 524 C	Page 57
Max. beam length 7 m	
Rainbow 724 C	Page 57



Load-bearing structure in cathoporesis treated steel painted with polyester powders

AUTOMATIC BARRIER FOR MOTOR VEHICLES

- Integrated control board with separate opening and closing inputs.
- Electrical and mechanical limit-switches supplied standard.
- Version 230V is supplied with the Encoder to ensure reversing of movement on detection of an obstacle.
- Rapidly transforms from right-hand to left-hand version.

Code	Name	Version	Voltage	Max. beam length
6130027	SPIN 4C ENC	Non-reversible with encoder and integrated Lynx 06	230V	5 m.*
6130028	SPIN 6C ENC	Non-reversible, Slow with encoder and integrated Lynx 06	230V	7 m.*

*No type of accessory can be fitted on the beams installed on Spin 3 models. The articulated kit cannot be installed on beams of over 4 meters installed on Spin 4 models. No type of accessory can be fitted on beams of over 6 meters installed on Spin 6 models.

OPERATOR DIMENSIONS

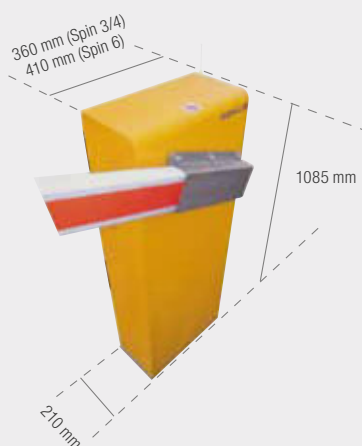

Technical Specifications	Spin 4 ENC	Spin 6 ENC
Power supply (V)		230
Electric motor (V)		230
Power (W)	250	380
Current (A)	1.1	1.7
Heat protection (°C)		140
Thrust capacitor (µF)		12.5
Max. torque (Nm)	100	150
Opening time (sec) ¹	4	8
Frequency of use at 20 °C	S3 - 50%	S3 - 60%
Operating ambient temperature (°C)		-20 +55
Protection class		IP44
Operator weight (Kg)	63	69

CONTROL BOARDS

Lynx 06

Page 69

N.B.

1 - Opening time and number of cycles calculated for correctly executed installations at the dimensions indicated in the installation instructions and without slow-downs.

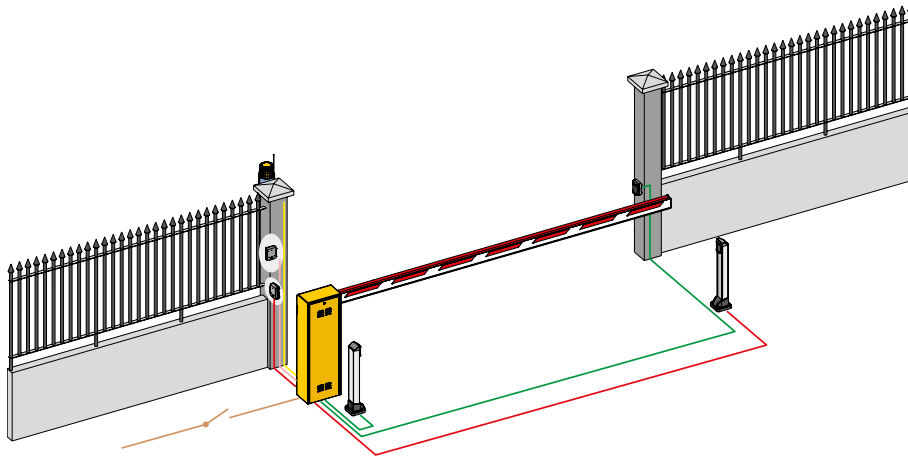

- Line3x1,5 mm²
- Flashing lamp2x1,5 mm²
- Selector2x0,5 mm²
- TX photocells2x0,5 mm²
- RX photocells4x0,5 mm²









TYPICAL INSTALLATION

Q.ty	Material description	Part number
1	SPIN 3C ENC barrier body with incorporated LYNX 06 control board	6130026
1	Foundation plate	58P1800
1	Rectangular beam 3000 mm	58P1802
1	Spring for SPIN 3	58F1812
1	RQFZ 433 MHz frequency module	6100346
1	Four-channels transmitter ECHO TX4 RC	6100334
1	GUARD 230V Flashing lamp	6100052
1	Pair of VEGA photocells	6100147
1	QUICK 1 Key-operated push-button for outdoor use	JA31101-15

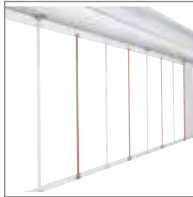
Material to add in order to get the configuration as per Wiring Diagram

Q.ty	Material description	Part number
1	Pair of ORION photocells	JA310
1	Pair of columns for photocells	JA325
2	Foundation plate for column	JA328

ACCESSORIES

					
ADJUSTABLE BEAM SUPPORT KIT	RELEASE KEY 6 additional release keys	SKIRT KIT In painted aluminium. Length 2m.	FIXED SUPPORT PLATE For fixed support.	FOUNDATION PLATE WITH ACCESSORIES	ARTICULATED BEAM Articulation kit For Spin 4
Code 428806	Code 58P2081	Code 428441	Code 737621	Code 58P1800	Code 58P1810
					
Adjustable end foot for beam support	ENCODER KIT Matchable with Lynx 06 control board.	RADIOFREQUENCY MODULE RQFZ 3PIN for GENIUS. 433 MHz			
Code 428805	Code 6100260	Code 6100346			
		868 MHz			
		Code 6100347			



BEAMS FOR SPIN 3 - SPIN 4

Aluminium beam painted with white epoxy powders, complete with retro-reflecting stickers and rubber profile. Dimensions 90 x 25 mm.

Model	Length (m.)	Passage width (m.)	Code
Beam 3 m.*	3	2.66	58P1802
Beam 4 m.	4	3.66	58P1803
Beam 5 m.**	5	4.66	4280305



SPRINGS FOR SPIN 3 - SPIN 4

Beam only (m.)	Articulated beam (m.)	Beam with foot (m.)	Beam with skirt (m.)	Spring thickness (mm.)	Code
2 - 2.7	2 - 2.7			4 - White	58F1811
2.7 - 3.4	2.7 - 3.4	2 - 2.7	2 - 2.7	4.5 - Red	58F1812
3.4 - 4	3.4 - 4	2.7 - 3.4	2.7 - 3.4	5 - Green	58F1813
4 - 4.6		3.4 - 4	3.4 - 4	5.5 - Yellow	58F1814
4.6 - 5		4 - 5	4 - 4.6	6 - Blue	58F1815
			4.6 - 5	6.5 - Grey	6100126



BEAMS FOR SPIN 6

Aluminium beam painted with white epoxy powders, complete with retro-reflecting stickers. Dimensions 100 x 50 mm.

Model	Length (m.)	Passage width (m.)	Code
Beam 5 m.**	5	4.62	428062
Beam 6 m.**	6	5.62	428063
Beam 7 m.**	7	6.62	428064



SPRINGS FOR SPIN 6

Beam only (m.)	Beam with foot (m.)	Beam with skirt (m.)	Round beam (m.)	Round beam in pieces (m.)	Spring thickness (mm.)	Code
4 - 4.8			4.3 - 4.9	4 - 4.6	6 - White	58F1816
4.8 - 5.5	4 - 4.8	4 - 4.8	4.9 - 5.6	4.6 - 5.4	6.5 - Red	58F1817
5.5 - 6.3	4.8 - 5.5	4.8 - 5.5	5.6 - 6.5	5.4 - 6.4	7 - Green	58F1818
6.3 - 7	5.5 - 6	5.5 - 6	6.5 - 7	6.4 - 7	8.5 - Yellow	6100024

* N.B. For the SPIN 3 model, beams with a length of over 3 m cannot be used.

** N.B. For Hold For Pickup shipments of beams of over 4m, please contact the shipping office.

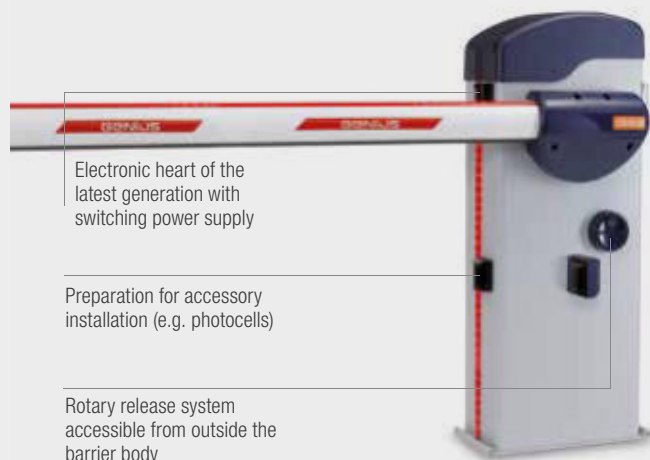

AUTOMATIC BARRIER FOR MOTOR VEHICLES

- Available version: 24V for passages up to 3, 5 and 7 m.
- The balance of the beam is automatic thanks to 1 or 2 springs.
- 7 m beam supplied in two parts together with a fixing joint.
- Lights for beam and barrier body.
- Ergonomically positioned and easily accessible control panel.
- Encoder for obstacle detection.
- User friendly rotary release system with customised key.
- Certified for continuous use (for more than 1.000.000 manoeuvres.)

Code	Name	Version	Voltage	Max. beam length
6130037	Rainbow Fast 324 C	Non-reversible FAST with encoder and integrated LYNX 07	24V	3 m.*
6130034	Rainbow 524 C	Non-reversible with encoder and integrated LYNX 07	24V	5 m.*
6130035	Rainbow 724 C	Non-reversible with encoder and integrated LYNX 08	24V	7 m.*

* Length indicated refers to the passage width, beam total length = passage width + 0.30 m approx.

OPERATOR DIMENSIONS



Technical Specifications	Rainbow Fast 324 C	Rainbow 524	Rainbow 724
Power supply (V)	230/115		
Electric motor (V)	24		
Max. power at thrust (W)	280		480
Nominal motor power (W)	160		220
Max. torque at 24Vdc (Nm)	155	140	370
Operating rated torque (Nm)	30	75	140
Opening/closing nominal time (sec) ¹	from 2 to 3	from 4 to 8	from 7 to 11
Frequency of use at 20 °C	70%		
Operating ambient temperature (°C)	-20 +55		
Noise (dBA)	>70		
Protection class	IP54		
Operator weight (Kg)	66		72

CONTROL BOARDS

Lynx 07 Page 69
Lynx 08 Page 69

N.B.

1 - Depending on the slow down setting.

ELECTRIC WIRING DIAGRAM

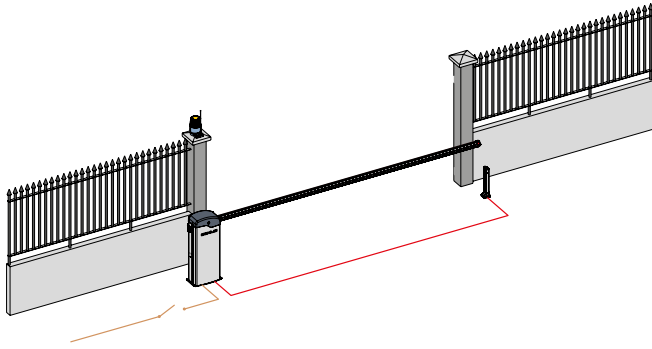







- Line3x1,5 mm²
- RX photocells4x0,5 mm²

TYPICAL INSTALLATION EXAMPLE

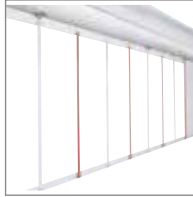
Q.ty	Material description	Part number
1	RAINBOW FAST 324 C barrier body with incorporated LYNX 07 control board	6130037
1	Foundation Plate	6100294
1	Round Beam 3300 mm (passage width 3000 mm)	428042
2	Spring for RAINBOW FAST 324 C	58F1812
1	RQFZ 868 MHz Module	6100347
1	Four-Channel Transmitter KILO TX2 JLC	6100332
1	24V GUARD Flashing Lamp	6100054
1	QUICK 1 key-operated selector for outdoor use	JA31101-15
1	Pair of ORION photocells	JA310
1	Column for photocell	JA325
1	Foundation plate for column	JA328

ACCESSORIES

 FOUNDATION PLATE With tie-rods. Code 6100294	 PHOTOCELL SUPPORT KIT Code 6100295	 KIT FOR BEAM ARTICULATION Length max. 4m. Code 428444	 SKIRT KIT In painted aluminium. Length 2m. Code 428441	 FIXED SUPPORT PLATE For fixed support. Code 737621	 STICKERS KIT 6 stickers with Genius brand. Code 6100201
 BATTERY CABLE KIT Cable to connect buffer batteries. Code 6100300	 BEAM LIGHTS KIT Beam lights connection. Code 390992	 BARRIER LIGHTS KIT Barrier lights connection. Code 6100299	 LIGHT TUBE In pairing with beam lights kit. 12 meter pack Code 390993	 RADIOFREQUENCY MODULE RQFZ 3PIN for GENIUS. 433 MHz Code 6100346	 ADJUSTABLE BEAM SUPPORT KIT Code 428806
 Adjustable end foot for beam support Code 428805	16,5 meter pack Code 6100297	868 MHz Code 6100347			

ACCESSORIES FOR RAINBOW



BEAMS FOR RAINBOW FAST 324 C

profile with section \varnothing 75 mm

Model	Length (m)	Passage (m)	Code
Beam 3 m.	3.30	3.00	428042



SPRINGS FOR RAINBOW FAST 324 C

Code	Description
58F1812	Spring – Red (L=400mm \varnothing 4.5mm)



SPRING CONFIGURATION FOR BEAMS - RAINBOW FAST 324 C

Beam only (m)	Beam with lights (m)	Q.ty Springs \varnothing 4.5mm Red - Code 58F1812
2,0 - 2,8	2,0 - 2,6	1
2,8 - 3,0	2,6 - 3,0	2

N.B. All the measures refer to passage width (total beam length = passage width + 0.30 m)



BEAMS FOR RAINBOW 524 C

profile with section \varnothing 75 mm

Model	Length (m)	Passage (m)	Code
Beam 3 m.	3.30	3.00	428042
Beam 4 m.	4.30	4.00	428043
Beam 5 m.	5.30	5.00	428044



SPRINGS FOR RAINBOW 524 C

Code	Description
6100290	Spring Soft – Violet (L=400mm \varnothing 6mm)
6100291	Spring Strong - Black (L=400mm \varnothing 6.5mm)



SPRING CONFIGURATION FOR BEAMS - RAINBOW 524 C - Single beam

Beam only (m)	Beam with lights (m)	Beam with foot (m)*	Beam with lights and foot (m)*	Beam with skirt (m)**	Beam with lights and skirt (m)**	Q.ty Springs \varnothing 6 mm Code 6100290	Q.ty Springs \varnothing 6.5 mm Code 6100291
3,0 - 3,4	3,0 - 3,4	3,0 - 3,3	3,0 - 3,2	3,0 - 3,3		1	
3,4 - 4,3	3,4 - 4,2	3,3 - 3,7	3,2 - 3,6	3,3 - 3,7	3,0 - 3,6		1
4,3 - 4,8	4,2 - 4,7	3,7 - 4,4	3,6 - 4,4	3,7 - 4,4	3,6 - 4,4	2	
4,8 - 5,0	4,7 - 5,0	4,4 - 5,0	4,4 - 5,0	4,4 - 5,0	4,4 - 5,0		2

N.B. All the measures refer to passage width (length of the beam = passage width + 0.30 m).Foot fixed at beam end ** Skirt fixed at 0.30 m from beam end (Skirt length max. = passage - 1.0 m)



BEAMS FOR RAINBOW 724 C

profile with elliptical section \varnothing 85/95 mm

Model	Length (m)	Passage (m)	Code
Beam 5 m.	5.30	5.00	428047
Beam 4 m.	4,00	7,00	428048
Beam 3.3 m.	3,30		428050
Joint	-		428616



SPRINGS FOR RAINBOW 724 C

Code	Description
6100292	Spring Soft – Violet (L=520mm \varnothing 7.5mm)
6100293	Spring Strong - Black (L=520mm \varnothing 8.5mm)



SPRING CONFIGURATION FOR BEAMS - RAINBOW 724 C - Single beam and/or parts

Beam only (m)	Beam with lights (m)	Beam with foot (m)*	Beam with lights and foot (m)*	Beam with skirt (m)**	Beam with lights and skirt (m)**	Q.ty Springs \varnothing 6 mm Code 6100292	Q.ty Springs \varnothing 6.5 mm Code 6100293
Single beam							
4,0 - 4,6	4,0 - 4,6	4,0 - 4,2	4,0 - 4,2	4,0 - 4,2	4,0 - 4,2	1	
4,6 - 5,0	4,6 - 5,0	4,2 - 5,0	4,2 - 4,8	4,2 - 5,0	4,2 - 4,8		1
			4,8 - 5,0		4,8 - 5,0	2	
Beam in parts with joint							
5,0 - 6,1	5,0 - 5,7	5,0 - 5,6	5,0 - 5,4	5,0 - 5,6	5,0 - 5,4	2	
6,1 - 7,0	5,7 - 7,0	5,6 - 6,5	5,4 - 6,5	5,6 - 6,5	5,4 - 6,5		2

N.B. All the measures refer to passage width (length of the beam = passage width + 0.38 m).Foot fixed at beam end ** Skirt fixed at 0.50 m from beam end (Skirt length max. = passage - 1 m)

Control boards

Selection

GUIDE

Swing gates

230V

Brain 17	Page 64
Brain 592	Page 64

24V

Brain 15	Page 65
--------------------	---------

Sliding gates

230V

Sprint 382	Page 65
Sprint 05	Page 66

24V

Sprint M24	Page 66
Sprint 11	Page 67

Up-and-over door

230V

Geo 07	Page 67
------------------	---------

24V

Geo 08	Page 68
Geo 09	Page 68

Rolling shutters

230V

Geo 13	Page 68
------------------	---------

Barriers

230V

Lynx 06	Page 69
-------------------	---------

24V

Lynx 07	Page 69
Lynx 08	Page 69

Comparative table

APPLICATION TYPE	SWING GATES			
CONTROL BOARD	BRAIN 592	BRAIN 17	BRAIN 15	SLIDING GATE SPRINT 382
Motor power supply	230Vac	230Vac	24Vdc	230Vac
Programming	microswitching	display and buttons	microswitching and buttons	display and buttons
"Function Logics "automatic" (with closing after time out)	2	3	3	3
Function Logics "semiautomatic"	3	3	3	3
Function Logics "dead-man"	1	1	1	2
Torque adjustment	independent for each motor (8 levels)	independent for each motor (50 levels)	✓	✓
Learning cycle of opening and closing positions	programmable through learning button	programmable through learning button	programmable through learning button	thanks to limit switches
Pause time programming	✓	✓	✓	✓
Total opening input	✓	✓	✓	✓
Total opening input/single leaf	✓	✓	✓	✓
Stop input (movement time out)	✓	✓	✓	✓
Safety contact in opening	✓	✓ (traditional and Bus G-Way)	✓ (Bus G-Way)	✓
Safety contact in closing	✓	✓ (traditional and Bus G-Way)	✓ (Bus G-Way)	✓
Fail-safe (photocells functioning test)	✓	✓	✓	✓
Modifiable safeties in closing	✓	✓		✓
Modifiable safeties in opening		✓		✓
Electric lock output	✓	✓	✓	
Limit switches inputs opening/closing		✓		✓
Safety edge input				✓
Courtesy light output	✓	✓	✓	✓
Flashing lamp output	✓	✓	✓	✓
Reversing Stroke (to facilitate the electric lock unhook)	✓	✓	✓	
Ram stroke (to facilitate the lock hook)	✓	✓	✓	
Electronic deceleration	(through Timecoder encoder)	✓	✓	✓
Electronic obstacle detection	✓	✓ (through absolute encoder PROcoder)	✓ (through virtual encoder ENV)	✓ (through encoder)
Opening leaf deceleration function (to avoid leaves overlapping)	✓	✓	✓	
Closing leaf deceleration function (to avoid leaves overlapping)"	✓	✓	✓	
Pre-flashing (5 sec.) before movement		✓	✓	✓
Diagnostic		✓	✓	✓
Cycle count				✓
Wind function			✓	
Soft-touch Function			✓	
Integrated receiver and decoding				
Integrated radio code decoding and connectors for RQFZ receiving modules with 3Pins		✓	✓	
Connector for plug in receivers with 5Pins	✓			✓
BUS G-Way		✓	✓	
USB Connector		✓ (firmware updating, radio, codes back-up, installation configuration back-up)		

SPRINT M24	SLIDING GATE SPRINT 05	SPRINT 11	UP-AND-OVER GATE GEO 07	BARRIERS LYNX 06	LYNX 07/08
24Vdc	230Vac	24Vdc	230Vac	230Vac	24Vdc
display and buttons	microswitching	microswitching	display and buttons	display and buttons	display and buttons
3	3	2	1	3	3
3	3	2	1	2	3
1					
✓	✓	✓	✓	programmable through display and buttons	self-learning
thanks to limit switches	thanks to limit switches	thanks to limit switches	thanks to limit switches	thanks to limit switches	programmable through learning button
✓	✓		✓	✓	✓
✓	✓	✓	✓	✓	✓
✓	✓	✓			
✓	✓	✓		✓	✓
✓ (Bus G-way)	✓	✓ (in opening and closing)	✓	✓ (in opening and closing)	✓ (in opening and closing)
✓ (Bus G-way)	✓	✓	✓	✓	✓
✓ (programmable output)			✓		✓
✓			✓		✓
✓			✓		
✓	✓		✓	✓	✓
programmable inputs (2)					
✓		✓	✓	✓	✓
✓	✓	✓	✓	✓	✓
✓	✓	✓	✓	✓ (adjustable)	✓ (adjustable)
✓	✓ (through encoder)	✓ (through virtual encoder ENV)	✓ (through encoder)	✓ (adjustable)	✓ (adjustable)
✓			✓		
✓			✓	✓	✓
				✓	✓
✓		✓		✓	✓
	✓		✓		
✓					



Brain 17

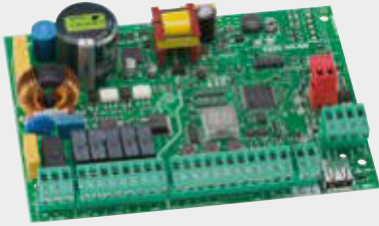

Code
6100304



ENCLOSURE FOR CONTROL BOARDS 230V

Code **JA320**

Power supply (Vac)	230 (+6% -10%) – 50Hz
Absorbed power (W)	4 in Stand by
Max. motor load (W)	800
Accessories max. load (mA)	500
Electric lock max. load (VA)	15
Operating ambient temperature (°C)	-20 +55
Protection fuses	2
Function logics	Automatic/Semi-automatic/Safety/Semi-automatic B/ Dead man C/Semi-automatic "Step by step"/ Automatic "Step by step"
Opening / closing time	Programmable (from 0 to 120 sec.)
Pause time	from 0 to 9,5 min.
Closing leaf delay	from 0 to 1,3 min.
Opening leaf delay	2 sec. (can be excluded by display)
Thrust force	Adjustable via display on 50 levels for each motor
Terminal board inputs	Open/Open free leaf/Stop/Limit switch/USB Opening and closing safety devices/Power supply + earth/BUS G-WAY
Terminal board outputs	Flashing lamp/Motors/ 24 Vdc Accessories Power Supply/Failsafe/12Vac Electric Lock Power Supply/ Signalling lamp 24Vdc
Quick-fit connector	3PIN each RQFZ Genius receiving Module/Integrated decodification
Selectable functions	Logics and pause time/Thrust force/ Opening and closing leaf delay/Reversing thrust/ Failsafe/Closing safety device logic/Pre-flashing/ Use of Limit Switches/Use of Encoder PROcoder
Programming keys	Simple or Complete work times learning, with or without limit switches or encoder, with or without slow-downs and radio code programming
USB Input	Firmware Update/Upload and Download installation configuration/Upload and Download radio codes

Brain 592



Code
JA592



ENCLOSURE FOR CONTROL BOARDS 230V

Code **JA320**



Power supply (Vac)	230 (+6% -10%) – 50Hz
Absorbed power (W)	10
Max. motor load (W)	800
Accessories max. load (mA)	500
Electric lock max. load (VA)	15
Operating ambient temperature (°C)	-20 +55
Protection fuses	2
Function logics	Automatic/Semi-automatic/Safety/Semi-automatic B/ Dead Man C/Semi-automatic "Step by Step"
Opening / closing time	Programmable (from 0 to 120 sec.)
Pause time	0, 10, 20, 30, 60, 120 sec.
Closing leaf delay	0, 5, 10, 20 sec.
Opening leaf delay	2 sec. (can be excluded per dip-switch)
Thrust force	Adjustable per dip-switch on 8 levels for each motor
Terminal board inputs	Open/Open free leaf/Stop/Limit Switch/Opening and Closing Safety Devices/Power Supply + earth
Terminal board outputs	Flashing lamp/Motors/Accessories power supply 24Vdc/Failsafe/Electric lock 12Vac power supply
Quick-fit connector	Genius 5PIN receivers
Selectable functions	Logics and Pause times/ Thrust Force/ Opening and Closing Leaf Delay/ Reversing Thrust/ Failsafe/Closing Safety Device logic/ Pre-flashing
Programming key	Simple or Complete work times learning with or without limit switches or encoder, with or without slow-downs

Brain 15



- With transformer in waterproof enclosure.

Code
6100263



BATTERY KIT
With recharging board.

Code **390923**



BUS INTERFACE BOARD
For traditional photo cell connection.

Code **6100236**



Power Supply (Vac)	230 (+6% -10%) – 50Hz
Central Power Supply (Vdc)	24 nominal
Absorbed power (W)	4
Max. motor load (W)	150 x 2
Accessories max. current (mA)	250
BUS accessories max. current (mA)	400
Operating ambient temperature (°C)	-20°C +55°C
Protection fuses	F1 = self-resetting; F2 = T2 A-250 V or T4 A-120 V
Function logics	Automatic/Automatic "Step by Step"/Semi-automatic/Semi-automatic "Step by Step"/Semi-automatic B/Dead man
Pause time	Variable depending on learning (max. 10 min.)
Terminal board inputs	Open A, Open B, Stop, BUS G-WAY (I/O)
Inputs in connector	Power supply/Battery/3 pin Radio module
Terminal board outputs	Motors/Flashing lamp/Accessory power supply/Electric lock/Service light contact (fixed 90 sec.)
Programmable functions	Logics/Speed/Anti-wind/Soft touch/Ram stroke
Learning functions	Pause time, 2nd closing leaf delay

CONTROL BOARDS FOR SLIDING GATES

Sprint 382



- Incorporated in Falcon M5 ENC, Falcon M8 C ENC, Falcon M14 C, Falcon M20 C, Blizzard 500 C ENC and Blizzard 900 C ENC gearmotors.

Code
JA382



230 V

Power supply (Vac)	230 (+6% -10%) – 50Hz
Absorbed power (W)	10
Max. motor load (W)	1000
Accessories max. load (mA)	500
Operating ambient temperature (°C)	-20 +55
Protection fuses	2
Function logics	Automatic/Automatic "Step by Step"/Semi-automatic/Safety/Semi-automatic B/Dead Man C/Semi-automatic "Step by Step"
Work time	Programmable (from 0 to 4 minutes)
Pause time	Programmable (from 0 to 4 minutes)
Thrust force	Adjustable on 50 levels
Terminal board inputs	Open/Partial open/Stop/Opening and Closing Safety Devices/Stop/Edge/Power Supply + earth
Inputs in connector	Limit switches in opening and closing/Encoder
Terminal board outputs	Flashing lamp/Motor/24 Vdc Accessories Power Supply/Signalling lamp 24Vdc/Failsafe
Quick-fit connector	Genius 5PIN receivers
Programming	3 keys (+, -, F) and display, simple or complete mode
Programmable functions Simple Mode	Function logics/Pause time/Thrust force/Gate direction
Programmable functions Complete Mode	Torque at start up/Braking/Failsafe/Pre-flashing/Indicator light/Safety device logic/Encoder/Slow-downs/Partial opening time/Work time/Assistance request/Cycles counter

Sprint M24



- Incorporated in Blizzard 400 C ENC and Blizzard 800 C ENC gearmotors.

Code
6020664



BATTERY KIT
With recharging board.

Code **390923**



24 V

Power supply (Vac)	230 (+6% -10%) – 50Hz
F1 fuse	2,5 A T
Accessories max. load (mA)	500
Flashing lamp	24Vdc - 15W
Operating ambient temperature (°C)	-20 +55
Function logics	Semi-automatic/Semi-automatic "Step by Step"/Automatic/Automatic "Step by Step"/Automatic Safety/Semiautomatic B/Dead Man
Work time	Programmable (from 0 to 9 min and 50 sec.)
Pause time	Programmable (from 0 to 9 min and 50 sec.)
Thrust force	Adjustable on 50 levels
Terminal board inputs	Open/Partial open/Stop/Power Supply voltage/Bus G-WAY
Terminal board outputs	Flashing lamp/Signalling lamp 24Vdc/Programmable output/Motor
Quick-fit connector	Battery/RQFZ radio-frequency module 3PIN receiver/Encoder
Programming	3 keys and display, simple or complete mode
Programmable functions Simple Mode	Operating logics/Pause time/Pushing force/Opening speed/Closing speed/Opening slow-down/Closing slow-down/Master-Slave
Programmable functions Complete Mode	Pre-flashing/Safety Logic/Partial Open/Working Time/Slow-down speed/Outputs/Partial Open Input and Stop (Safety edge)

Sprint 05



- Incorporated in Milord 5 C ENC and Milord 8 C ENC gearmotors

Code
6020312



230 V

Power supply (Vac)	230 (+6% -10%) – 50Hz
Absorbed power (W)	15
Max. motor load (W)	600
Accessories max. load (mA)	500
Operating ambient temperature (°C)	-20 +55
Protection fuses	2 (Power supply and accessories)
Function logics	Automatic, Manual
Opening / closing time	120 sec.
Pause time	Four pre-set levels
Motor power	Trimmer-adjustable
Terminal board inputs	Open A/Open B/Stop/Opening limit switch/Closing limit switch/Photocells/Power supply
Terminal board outputs	Accessories power supply 24V/Flashing lamp/Motor
Quick-fit connector	Connector for plug in receivers with 5 Pins/Encoder/Limit switch/Capacitor
Programmable functions	Function logics/Pause time/Clutch sensitivity, Operation with encoder/Safety device logic/Condominium function

Sprint 11



- Incorporated in Milord 424 ENV and Milord 824 ENV gearmotors

Code
6020548



G-WAY
BUS

ENV
PATENT

Power supply (Vac)	230
Absorbed power (W)	3
Max. power at initial thrust (W)	120
Accessories max. load (mA)	500
Operating ambient temperature (°C)	-20 +55
Function logics	Automatic/Automatic "Step by Step"/Semi-automatic/Semi-automatic "Step by Step"
Pause time	Through self-learning during programming
Motor power	Trimmer-adjustable
Terminal board connections	Open A/Open B/Stop/Opening and closing limit switches/Photocells/Flashing lamp/Motor/External batteries
Inputs with connector	RQFZ radio-frequency module 3PIN connector/Battery charger
Programmable functions	Automatic re-closing/Open A input/Photocells logic/Reversing during closing/Slow-down percentage/Deceleration speed



BATTERY KIT
With recharging board.

Code **390923**

Geo 07



- Incorporated in Eurobreeze 06 C and Eurobreeze 06 C Slow gearmotors

Code
6100151



Power supply (Vac)	230 (+6% -10%) – 50Hz
Max. absorbed power (W)	12
Max. motor load (W)	800
Accessories max. load (mA)	300
Operating ambient temperature (°C)	-20 +55
Circuit protection fuses	Network/accessories
Function logics	Automatic/semi-automatic
Work time	Programmable from 0 to 59 sec. (default 20 sec.)
Pause time	Programmable from 0 to 4 min. (default 2 min.)
Electronic clutch	Programmable on 50 levels
Limit switch tripping mode	4 operation types
Terminal board inputs	Open/Encoder/Opening and closing safety devices/Opening and closing flashing lamp 230Vac - 60W
Quick-fit connector	5 pin radio receiver
Terminal board outputs	Motor/230Vac external courtesy lamp/24Vdc Accessories power supply
Incorporated courtesy lamp max. load (W)	25
External courtesy lamp max. load (W)	250

N.B. For Eurobreeze 06 operators, compulsory encoder with limit switch code. 6100162.

CONTROL BOARDS FOR SHUTTERS

Geo 13



Code
6100306



230 V

Power supply (Vac)	230 (+6% -10%) – 50Hz
Absorbed power (W)	7
Max. motor load (W)	1300
Accessories max. load (mA)	500
Operating ambient temperature (°C)	-20 + 50
Protection fuses	2 (Power supply and accessories)
Function logics	Step by step/Automatic
Work time (Opening/Closing)	Min. 8 sec. max. 90 sec., trimmer-adjustable
Pause time	7 pause times selectable per dip-switch
Terminal board inputs	Mains power supply/Open/Stop/Obstacle detection
Quick-fit connector	5 pin connector for receiver board
Terminal board outputs	Motor power supply/Flashing lamp power supply/Accessories power supply



ENCLOSURE FOR GEO
13 CONTROL BOARDS
Protection class IP44
Dimensions: 185 x 185 x
100 mm.

Code **6100140**

CONTROL BOARDS FOR CEILING OPERATORS

Geo 08

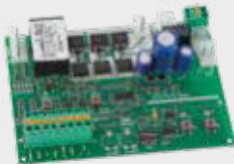

- Incorporated in Zodiac 60 gearmotor

Code
6020444



24 V

Power supply (Vac)	230
Accessories power supply (Vdc)	24
Accessories max. load (mA)	200
Terminal board connections	Open - Stop - Safety devices - Fail Safe - Flashing lamp LEDDY
Inputs with connector	Motor and Encoder Connector/Radio-frequency module RQFR Genius 3PIN/ Battery charger
Function logics	Automatic/Semi-automatic



BATTERY KIT
With recharging board.

Code **390923**



LEDDY
24 Vdc with integrated flashing.

Code **6100190**



**RADIOFREQUENCY
MODULE**
RQFZ 3PIN for GENIUS.
433 MHz

Code **6100346**

868 MHz

Code **6100347**

Geo 09



- Incorporated in Zodiac 100 gearmotor

Code
6020445

CONTROL BOARDS FOR BARRIERS

Lynx 06



- Incorporata nelle barriere Spin 4 C, Spin 6 C

Code
6100240



ENCLOSURE FOR 230V CONTROL BOARDS

Code **JA320**



Power Supply (Vac)	230 (+6% -10%) – 50Hz
Absorbed power (W)	3
Motor absorbed power (W)	500
Accessories max. load (mA)	500
Power supply and flashing lamp max. load	230 Vac 25 W
Power supply and max. load of barrier status indicator lamp	24 Vdc 5 W
Operating ambient temperature (°C)	-20 +55
Protection fuses	F1= T5A (transformer primary winding and motor) F2= T500mA (accessories and indicator lamp)
Function logics	Automatic/Automatic step by step/Semi-automatic/Semi-automatic step by step/Condominium
Opening / closing time	In self-learning mode during first manoeuvre
Pause time	Nine levels selectable up to a maximum of 4 minutes
Motor power	Adjustable on several levels
Slow-down time	Three selectable levels
Obstacle detection	With encoder
Selectable functions	Operates with or without encoder/Encoder sensitivity/Automatic re-closure/ Open input operation/Condominium function/Slow-down percentage/ Heating function/Immediate closure/Timer function/Soft start/Photocells operation/Maintenance request
Terminal board inputs	Opening/Closing/Photocells/Opening limit switches/Closing limit switches/ Stop/Mains power supply/Earthing
Inputs in connector	Radio module/Thrust capacitor/Encoder
Terminal board outputs	Accessories power supply/Flashing lamp/Motor/Indicator light

N.B. To combine with encoder kit for SPIN ENC - 6100260

CONTROL BOARDS FOR BARRIERS

Lynx 07



- Incorporated in Rainbow Fast 324 C and Rainbow 524 C barriers

Code
6020560



Voltage and frequency	230 Vac 50 Hz / 115 Vac 60 Hz
Absorbed power (W)	5
Max. power at thrust (W)	280
Accessories max. load (mA)	500
Operating ambient temperature (°C)	-20 +55
Protection fuses	2 fuses, replaceable + 4 fuses, self-resetting
Function logics	Automatic (A) / Automatic step by step (AP) / Manual (E) / Manual step by step (EP) / Condominium (D)
Opening/Closing max. time (sec)	60
Pause time	Adjustable on 7 levels of 5 seconds up to 4 minutes
Encoder sensitivity	Adjustable on four levels
Terminal board inputs	Mains power supply (230/115 Vac)/FCA and FCC limit switches/ Photocells/Stop/Open-Close/Open/Close/Failsafe/Batteries
Quick-fit connector	3 pin Molex connection for encoder/3 pin input for receiver module Motor power supply 24 Vdc/Flashing lamp 24 Vdc/24 Vdc indicator lamp max. 5 W/Beam lights 24Vdc/Synchronisation for opposing barriers/Accessories power supply/Battery charger
Terminal board outputs	
Board dimensions (mm)	168 x 146

Lynx 08



- For Rainbow 724 C
- Incorporated in Rainbow 724 C barrier

Code
6020561

Voltage and frequency	230 Vac 50 Hz / 115 Vac 60 Hz
Absorbed power (W)	5
Max. power at thrust (W)	480
Accessories max. load (mA)	500
Operating ambient temperature (°C)	-20 +55
Protection fuses	2 fuses, replaceable + 4 fuses, self-resetting
Function logics	Automatic (A) / Automatic step by step (AP) / Manual (E) / Manual step by step (EP) / Condominium (D)
Opening/Closing max. time (sec)	60
Pause time	Adjustable on 7 levels of 5 seconds up to 4 minutes
Encoder sensitivity	Adjustable on four levels
Terminal board inputs	Mains power supply (230/115 Vac) / Limit switch FCA e FCC / Photocells / Stop / Open-Close / Open / Close / Failsafe / Batteries
Quick-fit connector	3 pin Molex connection for encoder / 3 pin input for receiver module Motor power supply 24 Vdc/Flashing lamp 24 Vdc/24 Vdc indicator lamp max. 5 W/Beam lights 24Vdc/Synchronisation for opposing barriers/Accessories power supply/Battery charger
Terminal board outputs	
Board dimensions (mm)	168 x 176

Accessories

Selection

GUIDE

Accessories

Safety devices

Vega - Vega Bus	Page 72
Vega Wireless	Page 72
Orion	Page 72
Guard	Page 74
Control unit	Page 74
Wire edge	Page 74

Control devices

Quick 1	Page 75
Quick 2	Page 75
Keypad	Page 76
Decoding board	Page 76
Armo 2	Page 75

Radio controls and receivers

Kilo TX2 868	Page 77
Kilo TX4 868	Page 77
Kilo TX2 433	Page 78
Kilo TX4 433	Page 78
Echo TX4 433	Page 79

Various accessories

RMG 1	Page 80
RMG 2	Page 80
Electric lock	Page 80
Leaf block	Page 80

Vega - Vega Bus



Vega

Code
6100147

Vega Bus

Code
6100148

G-WAY
BUS

Self-aligning, outdoor photocells in traditional technology 24Vac/Vdc and/or BUS (G-WAY), extremely compact consisting of a transmitter and a receiver with modulated infra-red rays. Its compact size enables easy positioning in little space. Conformity to the EN12453 European standard - Type D, Category 3

Vega

Power supply	24Vac/Vdc
Absorbed power for torque	50mA
Nominal range	20 m
Automatic	Alignment

Vega Bus

Absorbed power for torque	20mA
Nominal range	15 m
Automatic	Alignment
Self-alignment angle	+/- 7° (m 15) +/- 13.5° (m 5)

Vega Wireless



Batteries not included

Code
6100248

Self-aligning, outdoor photocells in traditional technology 24Vac/Vdc and/or BUS (G-WAY), extremely compact consisting of a transmitter and a receiver with modulated infra-red rays. Its compact size enables easy positioning in little space. Conformity to the EN12453 European standard - Type D, Category 3

Power supply	12 - 24 Vac/Vdc
Max. range	15 m
Automatic	Alignment
RX absorbed power	30 mA
TX absorbed power	40 µA, Battery - 5 mA, 24 Vdc
3V CR2 TX battery duration and type	2 to 3 years ¹

1 - Battery duration can vary depending on the used battery charge, its type and environment/installation conditions.

Orion



Code
JA310

Directional, outdoor photocells with aligning facility and modulated infra-red rays. Professional and recommended for long distances. Highly versatile, it can also replace an embedded photocell, covering any hole in the pilaster, and enabling quick installation. Conformity to the EN12453 European standard - Type D, Category 3

Power supply	24Vdc (19÷35 Vdc)
Absorbed power	TX 20mA – RX 30mA
Nominal range	30 m
Detection angle	+/- 4°
Type of contacts	NO/NC

ACCESSORIES FOR ORION



FIXING PLATE
Side embossed plate.
1 pair

Code **JA331**



BUS INTERFACE BOARD
For traditional photozell connection.

Code **6100236**



COLUMNS
For photocells.
Package 2 pcs.
H 50 cm.

Code **JA325**



COLUMN
For photocells.
Package 2 pcs.
H 100 cm.

Code **JA326**



FOUNDATION PLATE
For column.

Code **JA328**

H 100 cm.
For double application.

Code **JA327**

ACCESSORIES FOR VEGA



COLUMN
For photocells.
Package 2 pcs.
H 50 cm.

Code **6100149**



FOUNDATION PLATE
For column.

Code **6100150**

Control unit



- Control unit for safety edge “E”, with facility for controlling up to two series consisting of four in-parallel edges.
- Number of edges selected through dip-switches.
- Signalling LED.
- DIN bar fitting.
- IP20 Protection class.
- Operating ambient temperature -20°C +55°C.

Code	Package
785200	1

Wire edge



- H. 60 mm, assembled, complete with terminal plug, securing profile in aluminium and safety microswitchings. Auxiliary safety device.

Length 1700 mm. Code	A13017	Length 2000 mm. Code	A13020
-------------------------	---------------	-------------------------	---------------

Guard



Guard is a new flashing lamp designed for installation in a host of configurations, enabling maximum vertical/horizontal positioning flexibility on pillars or walls. The outdoor support for installing the antenna cuts down on installation time and integrates all elements in a single product. Available in different versions 115/230V 12/24V, with fixed light (flashing managed by the control board) or intermittent light (flashing circuit in the flashing lamp).

Code	Description
6100052	Guard 230Vac 40W (intermittent)
6100054	Guard 24Vdc 15W (fixed light)
6100315	Guard LED 230Vac
6100316	Guard LED 24Vac

CONTROL DEVICES

Quick 1



Outdoor key-operated selector switch, one contact in NO/NC exchange, anti-break-in.

Code*	Package
JA31101 - 15	1

*(a different key number corresponds to each code).

Quick 2



Outdoor key-operated selector switch, two contacts in NO/NC exchange, anti-break-in.

Code*	Package
JA31301 - 15	1

*(a different key number corresponds to each code).

ACCESSORIES FOR QUICK



COLUMN
For photocells.
Package 2 pcs.
H 100 cm.

Code **JA326**



FOUNDATION PLATE
For column.

Code **JA328**



FIXING PLATE
Side embossed plate.
1 pair

Code **JA331**

Armo 2 key operated button



ARMO2 KEY-OPERATED SELECTOR WITH LEVER RELEASE

Code	Name
6100340	Armo 2 key operated button

Keypad



12-key keypad for outdoor use, anti break-in, in aluminium with painted steel cover.

Code	Name
JA108	Keypad

Decoding board



Decoding BOARD for digital keypad, two-channels, up to 4 keypads can be connected.

Code	Name
A10801	Decoding board

TRANSMITTERS

Kilo TX2



868MHz JLC SYSTEM

- The type of decoding is Rolling Code with Self-learning (**JLC** = Jumping Learning Code). The code generated by a complex algorithm is always different for every activation and synchronised with the data awaited by the receiver.
- The transmitter's code can be doubled on other transmitters thanks to the self-learning PATENTED technology (from transmitter to transmitter with no need to manage the receiver)

Kilo TX4



868Mhz Two-channel and Four-channel transmitters.

Code	Description	Model	Package
6100332	Two-channels	Kilo TX2	1

Code	Description	Model	Package
6100333	Four-channels	Kilo TX4	1

RECEIVERS

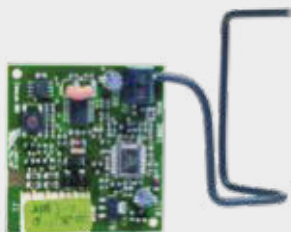

- Plug-in Receivers with 5pins molex connector compatible with Genius control boards including 5pins Plug-ins.

Code	Description	Package
6100352	868 JLC one-channel Receiver	1

Code	Description	Package
6100353	868 JLC Two-channels Receiver	1



- RQZ frequency Module with 3pins Plug-in connector, compatible with Genius control boards including integrated radio signal decoding and 3pins connector.

Code	Description	Package
6100347	868 RQZ Module	1



- Outdoor two-channel and four-channel receivers, with cable connection, 12-24 Vac Vdc power supply, including integrated radio signal decoding. Suitable for fixing on DIN rail.

Code	Description	Package
6100359	INTERMOD02 868MHz Receiver	1

Code	Description	Package
6100361	INTERMOD04 868MHz Receiver	1

ACCESSORIES FOR TRANSMITTERS/RECEIVERS



ANTENNA
868Mhz tuned antenna including securing bracket and 5m coaxial cable for outdoor installation or on GUARD lamp.



Interface Board
Interface Board including 5 pins box, for outdoor application. Power Supply 24Vac/Vdc.

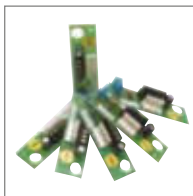

Interface Board
Set of 6 Interface boards for 5pin-receivers

Code **JA337**

Code **JA339**

Code **6020028**

TRANSMITTERS



Kilo TX2

433MHz JLC SYSTEM

- The type of decoding is Rolling Code with Self-learning (**JLC** = Jumping Learning Code). The code generated by a complex algorithm is always different for every activation and synchronised with the data awaited by the receiver.
- The transmitter's code can be doubled on other transmitters thanks to the Self-learning **PATENTED** technology (from transmitter to transmitter with no need to manage the receiver).



Kilo TX4

433MHz Two-channel and Four-channel transmitters.

Code	Description	Model	Package
6100330	Two-channels	Kilo TX2	1

Code	Description	Model	Package
6100331	Four-channels	Kilo TX4	1

RECEIVERS

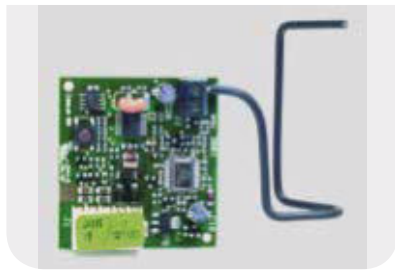

- Plug-in Receivers with 5pins molex connector compatible with Genius control boards including 5pins Plug-ins.

Code	Description	Package
6100351	433 JLC one-channel Receiver	1



- RQFZ frequency Module with 3pins Plug-in connector, compatible with Genius control boards including integrated radio signal decoding and 3pins connector.

Code	Description	Package
6100346	433 RQFZ Module	1



- Outdoor two-channel and four-channel receivers, with cable connection, 12-24 Vac Vdc power supply, including integrated radio signal decoding. Suitable for fixing on DIN rail.

Code	Description	Package
6100357	INTERMOD02 433Mhz Receiver	1

Code	Description	Package
6100358	INTERMOD04 433Mhz Receiver	1

ACCESSORIES FOR TRANSMITTERS/RECEIVERS



ANTENNA
433Mhz tuned antenna including securing bracket and 5m coaxial cable for outdoor installation or on GUARD lamp.



Interface Board
Interface Board including 5 pins box, for outdoor application. Power Supply 24Vac/Vdc.



Interface Board
Set of 6 Interface boards for 5pin-receivers

Code **6100012**

Code **JA339**

Code **6020028**

TRANSMITTERS

Echo TX4



RC 433MHz SYSTEM

- The type of decoding is RC = Rolling Code.
- The RC is a dynamic coding system, i.e. the code is always different for every activation and synchronised with the data awaited by the receiver.

433MHz four-channel transmitters.

Code	Description	Model	Package
6100334	Four-channels	ECHO TX4	1

RECEIVERS



- Plug-in Receivers with 5pins molex connector compatible with Genius control boards including 5pins Plug-ins.

Code	Description	Package
6100354	RC 433 one-channel Receiver	1

Code	Description	Package
6100355	Two-channel Receiver 433 RC	1



- RQFZ frequency Module with 3pins Plug-in connector, compatible with Genius control boards including integrated radio signal decoding and 3pins connector.

Code	Description	Package
6100346	433 RQFZ Module	1



- Outdoor two-channel and four-channel receivers, with cable connection, 12-24 Vac Vdc power supply, including integrated radio signal decoding. Suitable for fixing on DIN rail.

Code	Description	Package
6100357	INTERMOD02 433Mhz Receiver	1

Code	Description	Package
6100358	INTERMOD04 433Mhz Receiver	1

ACCESSORIES FOR TRANSMITTERS/RECEIVERS



ANTENNA
433Mhz tuned antenna including securing bracket and 5m coaxial cable for outdoor installation or on GUARD lamp.

Code **6100012**



Interface Board
Interface Board including 5 pins box, for outdoor application. Power Supply 24Vac/Vdc.

Code **JA339**



Interface Board
Set of 6 Interface boards for 5pin-receivers

Code **6020028**



RMG 1



Magnetic detector.

RMG 1 - One-channel

Code
6100131

Inductive vehicle detection system, with single or double channel, high performance, installed in a compact housing with connections by a standard round 11 PIN industrial connector.

The system's tripping sensitivity can be adjusted to adapt to any type of vehicle.

- Automatic frequency tuning.
- The oscillation frequency of each loop is controlled and measured at power-up.
- Four frequency settings.
- Continuous updating of work frequency.
- Loop interruption or short-circuit signalled.
- Multi-function signalling LED.
- Adjustment by potentiometers.
- Application on DIN guide.

Power supply (Vac/Vdc)	12 - 24	
Absorbed power (W)	< 2.5	
Operating ambient temperature	-30°C + 70 °C	
Loop inductivity (µH)	20 – 1000	
Frequency range (kHz)	20 - 130 kHz on 2 levels	
Tripping sensitivity	from 0.005% to 0.5% (Δ/f) in 250 stages	
Reaction time	25 ms	50 ms per channel
Presence time	from 1 min. to infinity in 250 stages	
Loop power cable (m)	< 100	
Relay contacts max. capacity	230 Vac – 5A (resistive)	
Pulse duration (ms)	100 or 500	
Dimensions (mm)	77 x 40 x 75 (h)	
Loops managed	1	2

RMG 2



Magnetic detector.

RMG 2 - Two-channels

Code
6100132

N.B.

Magnetic detectors must be installed in suitable boxes

Use a single-pole 1.5 mm² diameter cable for the loop.

The loop must be at least 15 cm away from metal objects, and at a depth of max. 5 cm from the definitive paving surface.

Electric lock



Code	Description	Package
712650	12Vac electric lock complete with floor strike plate	1
712990	Receiver slot with pilaster (swing gates)	1
712651001	Internal cylinder with 2 keys	1
712652001	External cylinder with 2 keys	1

Leaf block



Code	Description	Package
401026	Leaf lock, ambidextrous	1

GENERAL CONDITIONS OF SALE

1. OBJECT AND SCOPE

- 1.1 These “General Terms and Conditions of Sale” (hereinafter, the “**Conditions**”) apply to any and all sale or supply agreements (hereinafter, jointly defined, the “**Contracts**” and, individually, the “**Contract**”) executed between FAAC S.p.A. soc. Unipersonale, (hereinafter, “**FAAC**”), as vendor, and the direct client of FAAC, as purchaser (hereinafter, jointly defined, the “**Clients**” and, individually, the “**Client**”), which concerns the products manufactured and/or sold by FAAC, including but not limited automations for barriers, doors, gates, tubular, traffic bollards, access control software and their accessories (hereinafter, jointly defined, the “**Products**” and, individually, the “**Product**”). These General Conditions, therefore, apply only towards the Clients and don’t extend to third parties.
- 1.2 The final user (hereinafter, the “**Final User**”) to whom the Products are sold and/or installed must exclusively contact its own retailer for any warranty. It’s expressly understood that, if the Final User is a “consumer”, the warranty will be regulated by European laws for the consumer protection.
- 1.3 Except as provided in these Conditions, the right of recourse of the seller/retailer and/or the Client to FAAC is expressly excluded.
- 1.4 If the Client or the retailer also performs the installation of the Products, he must guarantee the correct installation, the connected activities (i.e. building works and electrical works) and the compliance with the local laws (if any) on safety, releasing all the necessary documentation.

2. PREVALENCE

- 2.1 In the event of any discrepancies between the provisions of this Conditions and those provided for in the Contract, the provisions of the Contract shall prevail, if agreed in writing.
- 2.2 In no case shall any general conditions of contract of the Client will be binding on FAAC, even if mentioned or included in orders or in any other documents transmitted by the Client to FAAC. No conduct of FAAC shall be interpreted or used to express tacit acceptance of FAAC to the general condition of contract of the Client. Therefore, all Contracts, offers, acceptance of orders and all deliveries by FAAC shall be deemed to have been made pursuant to the following General Conditions, except as otherwise expressly provided in writing by FAAC.

3. EXECUTION OF THE CONTRACT, TOLERANCES

- 3.1 Except as expressly indicated in point 3.3 below, the Contracts between FAAC and the Client may be concluded as follows:
 - (A) by signing a written agreement drafted in a sole document, being understood that, in this case, the Contract is deemed concluded when the last signature has been affixed;
 - (B) by the exchange of document (by @mail or, in general, any electronic/informatics tools), as follows: (i) the Client sends a purchase order (hereinafter, the “**Purchase Order**”) to FAAC containing indication of the Products, the quantity requested, the delivery terms, information regarding their use, and all the technical data necessary to identify the specifications of the Products (ii) FAAC sends to the Client its written acceptance (hereinafter, “**Order Confirmation**”), being understood that FAAC shall, at its sole discretion, be entitled to accept or refuse the purchase orders of the Client. In this case, the Contract will be considered executed once the Client receive the Order Confirmation; or
 - (C) by the exchange of the documents as follows: (i) FAAC sends to the Client an offer, having legal value as a proposal, in which it specifies as, but not limited to, the exact identification of the Products, the quantity, prices, and terms of delivery and payment (hereinafter, the “**Offer**”), and (ii) the Client signs the Offer in acceptance and returns it to FAAC, this last document having a legal acceptance value (hereinafter, the “**Acceptance**”). In this case, the Contract is concluded at the conditions set forth in the Offer upon receipt by FAAC of the written Acceptance. It is expressly understood that Acceptance by the Client must reach FAAC within the period of validity of the Offer indicated therein or the Offer loses all validity.
- 3.2 The Contract cannot be cancelled by the Client, except with the written consent of FAAC and reimbursement by the Client of any loss, cost, or damage suffered by FAAC because of the cancellation by the Client.
- 3.3 It is expressly understood that the execution of the Contract by FAAC is conditioned to the obligation of the Client to pay any previous invoices issued by FAAC and not paid by the Client in terms.

4. SELLING PRICE OF THE PRODUCTS

- 4.1 Unless otherwise agreed in writing by FAAC and the Client, the prices applicable to each sale/supply of Products are indicated in FAAC’s price list in force as of the date of conclusion of the Contract (hereinafter “**Selling Price**”), and the Selling Price is expressed in EURO.
- 4.2 The Selling Price, as well as any discounts applied by FAAC, shall be intended net of VAT and are subject to changes during the validity of FAAC’s price list.
- 4.3 The Selling Price is intended “FCA” (in accordance to the most recent edition of the ICC’S Incoterms) – at FAAC’s place of business in Zola Predosa (Bologna – Italy) or at other FAAC’s storages – VAT and shipping cost excluded.

5. PAYMENT

5.1 Except as otherwise agreed in writing, payment for all Products shall be effected by means of:

(A) An irrevocable letter of credit (“**L/C**”), confirmed by a primary International bank, which has an official branch in the Client's country, in compliance with publication 500 of the International Chamber of Commerce as updated from time to time, and valid for at least 30 days from the anticipated date of final delivery; or in alternative,

(B) a bank wire transfer in accordance to the payment terms as agreed in writing by FAAC and the Client.

5.2 Delivery of the Products is conditional upon the issuing of the above L/C's or the payment of the price by any other means, which may have otherwise been authorised in writing by FAAC. Regardless of the means of payment agreed upon, it is understood that payments shall be deemed to have been effected at FAAC's place of business.

5.3 Under no circumstance shall the Client be entitled to suspend and/or delay payment of the Products or raise any claim in relation thereto until full payment has been made. In the event of any payment, FAAC shall be entitled to exercise its right provided under the laws in force where the Client is established in relation to late payment in commercial transaction, without prejudice to its right to seek any further damages. In any event, FAAC may, (i) terminate the Contract in relation to the Products not yet delivered and/or (ii) delay the carrying out of any order in hand, inter alia, by suspending delivery of the Products until such time as all outstanding debts owed by the Client to FAAC have been paid.

6. OTHER EXPENSES AND DUTIES

6.1 Unless otherwise agreed between FAAC and the Client, the price applied to any sale of Products are for delivery “FCA” (in accordance to the most recent edition of the ICC's Incoterms) at FAAC's place of business in Zola Predosa (Bologna – Italy) or at other FAAC's storages, therefore FAAC shall not enter into any shipment or transportation agreement and shall not insure the Products, unless the Client should so expressly instruct FAAC in writing, being understood in any event that any and all risk and expenses in relation thereto shall be borne exclusively by the Client.

6.2 The Client agrees promptly to collect the Products upon receiving notice that the Products are ready and at its disposal and, in any event, within 8 (eight) days of the date of said notice.

6.3 Any and all taxes, duties, levies, licenses, authorisation, permits and any and all tax and administrative formalities relating to the importation and/or resale of the Products shall be borne and carried out exclusively by the Client or, alternatively, they may be carried out by FAAC at the Client's sole risk, expense and responsibility.

6.4 Standard packing of the Products suitable for air, land and sea transportation in container will be provided by FAAC free of charge. If the Client requires any special packing, the full cost of said special packing shall be invoiced by FAAC to the Client.

7. DELIVERY

7.1 All the delivery dates given by FAAC shall be deemed as indicative, not binding and are expressed in working days. In any event of late delivery, the Client shall not be entitled to cancel the Contract or to any compensation for damages of whatever nature.

7.2 Unless otherwise agreed between FAAC and the Client, the Products shall be delivered “FCA” (in accordance to the most recent edition of the ICC's Incoterms) at FAAC's place of business in Zola Predosa (Bologna – Italy) or at other FAAC's storages.

8. QUALITY STANDARDS

8.1 FAAC does not represent or guarantee the Client that the Products comply with the applicable laws and regulations in force in the country where the Client is established or where the Products are to be sold and/or delivered and/or installed. FAAC shall have no obligation to modify the Product in compliance with said laws or regulations and the Client shall be solely responsible for ensuring that the Product and any services of the Client conform to the applicable technical and safety standards, laws, and regulations in force in that country.

8.2 The Client, moreover, acknowledges that the Products may be dangerous to persons or property when not installed or not used in strict compliance with the instructions for installation and use supplied by FAAC and with the safety requirements specified in the technical standards. FAAC expressly disclaims liability for any personal injury or property damage resulting from installation or use of the Products, other than in strict compliance with FAAC's written instructions with respect to installation and use, or from installation or use of the Products together with safety accessories or other Products not manufactured by FAAC, being understood that the maximum liability of FAAC to the Client arising out of or in connection with the Product and based on a claim of breach or under the warranty, shall in no case exceed the price paid to FAAC for the Product which gives rise to the claim and, therefore, in no event FAAC shall not be liable also for special and consequential damages including, without limitation, loss of profits and indirect damages.

9. WARRANTY

- 9.1 FAAC warrants and guarantees to the Client that all new Products shall be free from manufacturing defects, under normal use and service, for a period of (i) 30 (thirty) months from the manufacturing date (as shown on the tag plate of each Product) for all Products other than Tubular Motor (the “**Warranty Period for Products other than Tubular Motor**”); and (ii) 5 (five) years from the manufacturing date (as shown on the tag plate of each Product) for all Products included in the tubular motor range (the “**Warranty Period Tubular Motor**”).
- 9.2 The Client acknowledges and agrees that FAAC’s warranty is expressly limited to manufacturing defects and that said warranty shall not extend to any damage to the Products resulting from other causes, including, without limitation, misuse, transportation, or faulty installation thereof. The maximum liability of FAAC to the Client, arising out of or in connection with the Products in question and based on a claim of breach or repudiation of warranty, shall in no case exceed the price paid to FAAC for the Product(s) in question and, in addition, FAAC shall not be liable also for special and consequential damages of the Client including, without limitation, loss of profits and indirect damages. Should FAAC be in breach of its representation and warranty under this article 9, FAAC’s entire liability and the Client’s exclusive remedy shall be the repair or replacement of the defective part Product free of charge at FAAC’s own workshop unless otherwise agreed in writing between FAAC and the Client. The Client shall send the part to be repaired or replaced, free of charge, and FAAC shall examine said part to determine whether it is defective and whether the manufacturer is responsible for the defect; in which case only FAAC shall repair or replace the part, in its sole discretion, and shall send the repaired or replacement part to the Client who shall bear the cost of transportation and installation only. Any Products which may have been returned without FAAC’s written authorisation shall not entitle the Client to any credit notes or reimbursement. In any event, any and or risk and expenses relating to the return of the Products shall be born exclusively by the Client. Any claims relating to the defects of the Product in question, must be sent to FAAC by registered letter with return receipt requested or by @mail or, in general, any electronic/informatics tools within 8 (eight) days following the receiving date of the Product in the case of evident defects; and 8 (eight) days following the date of discovery in the case of latent defects and in any event, within the Warranty Period for Products other than Tubular Motor and/or the Warranty Period Tubular Motor, failing which the Client shall lose all right to bring any claim in relations thereto. Any and all further or other warranties, are they expressed or implied, including without limitation any warranties provided by law, shall be deemed excluded and superseded by these conditions. FAAC further disclaims all expressed, statutory, or implied warranties applicable to Products and accessories which are not manufactured by it.
- 9.3 Unless otherwise agreed between FAAC and the Client, (i) the Product, repaired or replaced, will sent to the Client in full charge of the Client (FCA); (ii) warranty intervention does not extend the original warranty period of the Product and does not initiate a new warranty period for the repaired or replaced part; (iii) the repaired or replaced part will be owned by FAAC; (iv) the Customer will lose the warranty if he does not pay the invoices.
- 9.4 Warranty excludes the damages connected to: (i) transport; (ii) faults and/or negligence and/or inadequacy of the installation and of the use of the electrical system; (iii) tampering by unauthorized personnel or the use of components and / or non-original spare parts; (iv) defects caused by chemical agents or atmospheric and / or natural phenomena in general; (v) the installation of the Products not according to the rules of the art, safety and compliance of use expressly indicated in the technical documentation of the same Products. Furthermore, warranty not include (vi) the consumables; (vii) interventions for verification of any faults not found; (viii) compensation for the period of inactivity of the plant where the Products are installed.

10. TITLE

- 10.1 Title to the Products shall pass to the Client only upon payment in full of the sale price of the Products. In the event of default by the Client, FAAC shall be entitled, without any formalities, including notice of default, to repossess all of the Products with respect to which title has not yet passed to the Client, wherever said Products may be; in addition, FAAC reserve the right to seek any other judicial remedies available to it in respect of the damages suffered.

11. PRIVACY

- 11.1 Under the clause 13 of the del Regulation (UE) 2016/679, FAAC, as data controller (hereinafter, the “Data Controller”), inform the Client that all the data disclosed by the Client in the performance of the Contract which is personal shall be processed according to such Regulation 2016/679 and, therefore, declare as follows: (a) the processing of data will be carried out, in compliance with such Regulations, by means of paper, computer or telematics means capable of storing, managing, transmitting the data itself, however by means of suitable means to guarantee their security and confidentiality; (b) the objective of the processing will be related and instrumental to the conclusion, management and execution of the General Conditions and the Contracts and for any administrative and accounting purposes connected with them (for example, but not limited to, handling of orders and invoices, drafting contracts including credit insurance; assignment of claim agreement; transportation and/or shipment agreement; etc.); for marketing purposes related to similar products to those already acquired, because it is a lawful interest of FAAC (under clause 6, Regulation 2016/679); for purposes related to the enforcement of legal obligations, regulations, Italian and UE regulations, as well as to order of competent Authority; (c) the transfer of the data is mandatory for all that is required by legal and contractual obligations and therefore any refusal by the Client to communicate the data or to enable it to be processed subsequently may cause the impossibility for FAAC to give rise to the obligations of the Contract; the transfer is discretionary for marketing activities; (d) the data will not be disclosed, but can be communicated exclusively for the above purposes, to the appropriate authorized persons for which will be necessary to make such communication for the purposes set out in the above letter (b), such as the other companies in the group to which FAAC belongs; (e) the Client has the right to access to its personal data, emend, cancel, limit the processing, to oppose, in addition to the right to portability, by submitting formal requests directly to the Data Controller; the Client has also the right to make a claim to the supervisory Authorities; (f) the data will be stored for commercial and marketing purposes for all the duration of the commercial relationship between FAAC and the client; after for the sole law’s purpose; (g) the Data Controller is FAAC, Via Calari n. 10, Zola Predosa, Bologna - Italy.

12. FORCE MAJEURE

12.1 FAAC shall not be liable or reasonable to the Client for any failure or delay in performing of fulfilling any obligations undertaken in reference to the supply of the Product when such failure or delay is caused by occurrences beyond FAAC's reasonable control, or in any case caused by an event of force majeure, including, but not limited to, late delivery or non-delivery of materials by suppliers, strikes and other trade union actions, terrorist activities, suspension of electrical energy or difficulties in transportation. In the event of such events, the activities which cannot be performed shall be automatically postponed, without any penalty for FAAC, for a period equal to the situation of force majeure.

13. APPLICABLE LAW AND DISPUTE RESOLUTIONS

13.1 Unless provided at art. 13.2 below, any dispute that may arise in relation to the interpretation, performance, execution, validity and/or dissolution of the Contracts and/or connected to the Contracts, will be exclusively governed to the Italian laws - with the express exclusion of the 1980 Vienna Convention - and, the Court of Milan will have exclusive jurisdiction.

13.2 Any dispute related to and/or connected to breach of the obligations set forth in the art. 5 of this Condition will be exclusively governed to the Client's national laws - with the express exclusion of the 1980 Vienna Convention - and the competent Court will be the court where the Client is established.

14. OTHER

14.1 The invalidity or unenforceability of any provision, or portion thereof, of this Conditions shall not affect the validity or enforceability of any other provision.

14.2 Any failure by FAAC to enforce any of its rights under this General Conditions shall not be construed as a waiver of said rights.

14.3 This General Conditions supersede any prior agreement, whether written or oral, between FAAC and the Client, with respect to the subject matter.

14.4 Any amendment to this General Conditions shall be effective only if made in writing and duly signed by the FAAC and the Client.

14.5 Any software contained in the Products is the property of FAAC and is licensed free of charge and under non-exclusive basis, unless otherwise agreed in writing between the parties.

14.6 The Client is aware that the Products are covered by patents and are the subject of know-how and design constituting the exclusive industrial property of FAAC. It is expressly forbidden for the Client to violate these rights of FAAC and in any case to remove, suppress and/or alter the trademarks and other distinctive signs or initials of any kind affixed to the Products, as well as to add new ones of any kind and/or nature. Unless authorized in writing by FAAC, any form of reproduction and/or use of the FAAC trademark and/or any other distinctive sign present on the Products is prohibited.

14.7 FAAC has implemented a Code of Ethics which is available on web site of [FAAC www.faac.it](http://www.faac.it) or www.faacgroup.com and which the Client accepts to respect in each party.

Analytical index by code

104001	13	428048	59	6020560	69	6100247	47
104002	13	428050	59	6020561	69	6100248	72
104005	14	428062	56	6020664	66	6100253	19
390120	45	428063	56	6100012	78	6100254	10
390126	45	428064	56	6100013	39	6100260	55
390132	45	428441	55	6100014	43	6100263	29
390226	45	428444	58	6100015	43	6100264	43
390232	45	428616	59	6100043	19	6100273	47
390488	45	428805	55	6100052	10	6100275	47
390607	43	428806	55	6100054	12	6100285	45
390612	31	490111	31	6100059	45	6100286	31
390682	27	712650	80	6100110	31	6100294	58
390765	45	712990	80	6100126	56	6100295	58
390768	45	722121	31	6100127	43	6100297	58
390923	19	722122	31	6100131	80	6100299	58
390992	58	737000	14	6100132	80	6100300	58
390993	58	737001	35	6100140	47	6100304	10
391450	47	737003	35	6100147	10	6100306	47
391452	47	737621	55	6100148	12	6100315	74
401026	80	738709	43	6100149	25	6100316	74
404035	31	785200	74	6100150	25	6100319	29
424001	25	4280305	56	6100151	67	6100320	29
424413	35	6020028	77	6100156	45	6100321	29
428042	58	6020312	66	6100190	45	6100324	19
428043	59	6020444	68	6100201	58	6100330	78
428044	59	6020445	68	6100236	65	6100331	78
428047	59	6020548	67	6100240	69	6100332	10

6100333	77	6130037	57	6170178	22	58P0658	51
6100334	10	6140003	46	51700811.	12	58P0659	51
6100335	21	6140004	46	51700931.	11	58P1573	31
6100340	25	6140005	46	51701271.	10	58P1800	55
6100344	35	6140009	46	51701281.	10	58P1802	55
6100345	35	6140010	46	61100821.	13	58P1803	56
6100346	25	6170026	10	61100861.	13	58P1810	55
6100347	10	6170027	10	712651001	80	58P2015	43
6100351	78	6170030	18	712652001	80	58P2081	55
6100352	13	6170031	18	00058P0656	51	A10801	76
6100353	77	6170038	18	58F1811	56	A13017	74
6100354	10	6170039	18	58F1812	55	A13020	74
6100355	79	6170077	30	58F1813	56	JA108.	76
6100357	78	6170080	30	58F1814	56	JA146.	35
6100358	78	6170082	28	58F1815	56	JA147.	35
6100359	77	6170116	11	58P0050	31	JA148.	35
6100361	77	6170117	22	58P0051	31	JA310.	19
6110002	38	6170118	22	58P0052	31	JA31101	10
6110022	38	6170120	22	58P0199	19	JA31101 - 15.	75
6110080	14	6170121	22	58P0371	43	JA31301 - 15.	75
6120036	42	6170122	22	58P0379	43	JA320.	10
6120041	44	6170124	20	58P0380	43	JA325.	19
6120042	44	6170126	20	58P0381	43	JA326.	73
6120045	42	6170135	12	58P0386	43	JA327.	73
6130026	55	6170136	12	58P0392	43	JA328.	19
6130027	54	6170150	26	58P0583	43	JA331.	73
6130028	54	6170151	26	58P0584	43	JA337.	77
6130034	57	6170152	50	58P0587	43	JA339.	77
6130035	57	6170153	50	58P0656	51	JA382.	65

NOTE

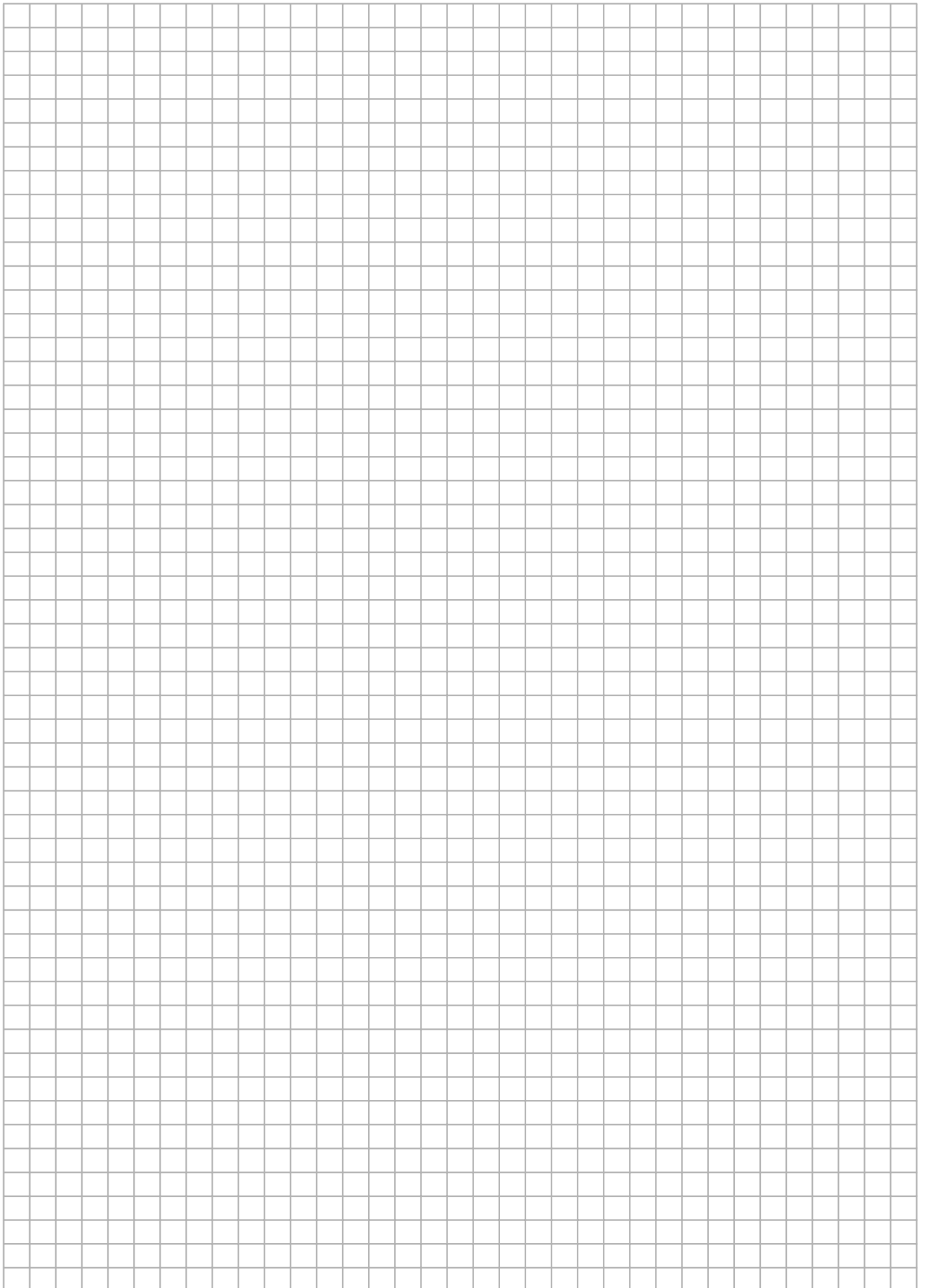



Automated systems for
SWING GATES



Automated systems for
SLIDING GATES



Automated systems for
GARAGE DOORS AND SHUTTERS



Automated systems for
INDUSTRIAL DOORS

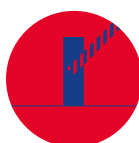

AUTOMATIC BARRIERS